



# OWNER'S MANUAL

*Designed for Campers,  
by Campers.*

Designed for Campers,  
by Campers.



Dear Valued Customer,

Congratulations! And thank you for your business. This owner's manual outlines the Manufactured Recreational Vehicles, LLC One Year Limited Warranty.

We encourage you to follow the product delivery inspection procedures with your selling dealer. You should receive an extensive walk-through and demonstration of your RV and the warranty statement contained in this manual should be fully explained to you. The desired result is that you have been informed of the warranty provided, the operation, the maintenance required, and the details of the responsibilities of the manufacturer, dealer, and retail partnership.

RV's are to be used as temporary living quarters for camping and travel uses. Maintenance of your recreational vehicle is important to keeping your unit in good condition. Failing to provide maintenance and care to your unit, as suggested, will result in loss of warranty coverage. Review the copy of your towable limited warranty, which has been supplied to you with your warranty registration form. The purpose of the owner's manual is to provide the most current information available concerning recreational vehicles. Operation and minor maintenance is the main focus of this manual. Critical safety warnings are included and must be read and obeyed.





## Towable Limited Warranty

**SUMMARY OF WARRANTY:** Warrants the structure of every towable recreational vehicle purchased from an authorized dealer to the first retail consumer for a period of 1 year, to be free from substantial defects in materials and workmanship when used for its intended purpose. The warranty period begins on the date of purchase or the date the unit is first placed in service, whichever is earlier. For purposes of this Towable Limited Warranty ("TLW"), the term "structure" includes the interior and exterior sidewalls, floor, roof, and frame. This towable limited warranty does not apply to towable recreational vehicles purchased from any source other than an authorized VENTURE Recreational Vehicle dealer.

**EXCLUSIONS FROM WARRANTY:** Excluded from coverage under the TLW are: (1) items added, changed, or modified after the unit left the possession of VENTURE Recreational Vehicles ; (2) units used for any commercial purpose; (3) units used for full-time residential use or more than occasional recreational use; (4) wear and tear caused by normal usage by the consumer, including but not limited to, fading or discoloration of soft goods [e.g. tents, upholstery, drapes, carpet, vinyl, screens, cushions, and mattress], fading or discoloration of exterior or fiberglass components, tears, punctures, soiling, mildew, mold, and the effects of moisture condensation inside the unit; (5) the effects of alteration, tampering, mishandling, neglect, abuse, misuse, weather, acts of nature, or corrosive atmospheres that promote rusting, oxidation, or pitting; (6) minor imperfections that do not interfere or affect the suitability of the unit for its intended use; (7) the effects of consumer's or transferee's failure to perform normal and routine maintenance [e.g. inspections, lubrication, adjustments, tightening of screws and bolts, tightening of lug nuts and wheels, sealing, rotating, cleaning, or other damages resulting from failing to follow the maintenance schedule and procedures in the owner's manual; (8) damages resulting from misalignment or alignments to axles or spindles caused by improper maintenance, modification, loading, unloading, road hazards, road defects, off road travel, or tire failures; (9) damages caused by the negligent or intentional use or misuse of the unit by the consumer or transferee, including but not limited to, occurrences while towing the unit; (10) claims made for alignment or adjustment of patio doors [Note: any unit with a patio door is not intended to be towed like a travel trailer, and must be permanently parked on a lot. If such a unit is towed for recreational use, this TLW is voided in regard to the patio door and the surrounding structures]; (11) loss or damage caused by a person or business as a result of transporting the unit after the sale to the consumer, delivering the unit, or parking the unit; (12) loss or damage to the plumbing system caused by freezing; (13) claims for personal injuries of any type; (14) costs of transportation of the unit for repairs; and (15) components that are warranted separately by another manufacturer the warranty provided by a component manufacturer is the sole responsibility of that manufacturer and does not warrant those components. Please refer to the warranties issued by the component manufacturer for the terms and conditions of such warranties.

**TO OBTAIN WARRANTY SERVICE:** Warranty service may be performed only at VENTURE Recreational Vehicles or at VENTURE Recreational Vehicles authorized dealers and service centers. Contact VENTURE Recreational Vehicles for a list of authorized dealers and service centers. **REPAIRS OR REPLACEMENTS BY UNAUTHORIZED DEALERS OR SERVICE CENTERS WILL VOID THIS TLW.** If the consumer believes that a claimed defect is covered by the TLW, contact must be made with an authorized dealer or service center **WITHIN THE WARRANTY PERIOD.** Enough information must be given to attempt to resolve the claimed problem. Should VENTURE Recreational Vehicles determine that repair or replacement is appropriate, the consumer must deliver the unit to the dealer or service center as directed. Delivery shall occur no later than thirty (30) days after the authorization for repair or replacement. Do not deliver your unit to VENTURE Recreational Vehicles, an authorized dealer or service center without prior authorization. All costs incurred by the consumer for transportation for warranty service shall be the sole responsibility of the consumer. The dealer or service center shall repair or replace any warranted defect within a reasonable time, but no later than ninety (90) days after delivery by the consumer. Should the unit not be repaired within the said period, then the consumer must contact VENTURE Recreational Vehicles by **CERTIFIED MAIL** with a written description of the claimed warranted defect and the efforts to remedy it. **FAILURE TO SO NOTIFY VENTURE Recreational Vehicles IN THIS REGARD SHALL RENDER THIS TLW VOID AS TO THE CLAIMED DEFECT.** After receipt of such notice, VENTURE Recreational Vehicles shall repair or replace such warranted defect within a reasonable time, but not later than ninety (90) days after delivery by the consumer. The scheduling of warranty work at an authorized dealer or service center is not controlled by VENTURE Recreational Vehicles and delays may be experienced. VENTURE Recreational Vehicles is not responsible for loss of use of the unit, expenses for fuel, telephone, food, lodging, travel, loss of income or revenue, or loss of or damage to personal property.

**DISCLAIMER AND LIMITATIONS OF WARRANTIES:** NEITHER VENTURE Recreational Vehicles, LLC., NOR IT'S DEALERS SHALL BE LIABLE FOR INCIDENTAL, CONSEQUENTIAL, INDIRECT, SPECIAL, OR PUNITIVE DAMAGES OF ANY KIND OR ANY OTHER FINANCIAL LOSS ARISING OUT OF OR IN CONNECTION WITH THE SALE OR USE OF THIS PRODUCT, WHETHER BASED IN CONTRACT, TORT, STRICT LIABILITY, EQUITY, OR ANY OTHER THEORY, EVEN IF VENTURE Recreational Vehicles HAS BEEN ADVISED OF THE POSSIBILITY OF SUCH DAMAGES. VENTURE Recreational Vehicles ENTIRE LIABILITY SHALL BE LIMITED TO REPAIR OR REPLACEMENT, AT VENTURE Recreational Vehicles SOLE OPTION. THE UNITED NATIONS CONVENTION ON CONTRACTS FOR THE INTERNATIONAL SALE OF GOODS IS HEREBY EXCLUDED IN ITS ENTIRETY FROM APPLICATION TO THIS TLW. THE TLW, AND THE REMEDIES HEREUNDER, ARE EXCLUSIVE AND IN LIEU OF ALL OTHER WARRANTIES, EXPRESS OR IMPLIED, INCLUDING WARRANTIES OF MERCHANTABILITY, FITNESS FOR A PARTICULAR PURPOSE, CORRESPONDENCE WITH DESCRIPTION, AND NON-INFRINGEMENT, ALL OF WHICH ARE EXPRESSLY DISCLAIMED BY VENTURE Recreational Vehicles. THIS TLW GIVES YOU SPECIFIC LEGAL RIGHTS AND YOU MAY ALSO HAVE OTHER RIGHTS THAT VARY DEPENDING ON LOCAL LAW. SOME STATES LIMIT OR PROHIBIT LIMITATIONS OF WARRANTIES, SO THE ABOVE MAY NOT APPLY TO YOU. YOU SHOULD CONSULT A COMPETENT ATTORNEY FOR LEGAL ADVICE.

**MISCELLANEOUS:** No repair or replacement effected shall cause any extension or renewal of the warranty period. VENTURE Recreational Vehicles may make parts and/or design changes from time to time without notice and repairs or replacements may be made with new or different parts. VENTURE Recreational Vehicles reserves the right to make changes in the design or material of its products without incurring any obligation to incorporate such changes in any product previously manufactured. At VENTURE Recreational Vehicles, sole option, any dispute concerning any warranted defect may be resolved through mediation or arbitration. This TLW shall be governed by the laws of the State of Indiana, and any legal action shall be brought only in the Circuit or Superior Court of LaGrange County, Indiana. In case of conflicts between this TLW and any other warranties issued or conveyed by VENTURE Recreational Vehicles, the terms of this TLW shall govern.



**ALTERNATIVE DISPUTE RESOLUTION:** The parties shall attempt in good faith to resolve any disputes by negotiations. If unsuccessful, VENTURE Recreational Vehicles may, in its sole discretion, elect to submit the matter to binding arbitration and, if such election is exercised, the consumer covenants and agrees that he, she, they, or it shall submit any such disputes to such binding arbitration. The arbitral body shall be either the American Arbitration Association or the National Arbitration Foundation, and the rules of the body chosen by VENTURE Recreational Vehicles shall govern except to the extent the same conflict with the Indiana Uniform Arbitration Act, which shall govern. The arbitrator is expressly empowered to enter an award of default against any party in the event of (a) the failure or refusal of such party to comply with any deadline fixed by the arbitrator; (b) the failure or refusal of such party to make timely payment of any fees, expenses, or other charges billed by the arbitrator; or (c) any other failure or refusal by such party to cooperate and participate in any aspect of the arbitration proceedings. The arbitrator will admit only relevant and reliable evidence at the hearing, but no rules of evidence are specified for use. The hearing shall be electronically recorded by an Indiana Notary Public or other officer authorized by Indiana law to administer oaths, and all witnesses who shall testify shall be sworn on oath, to tell the truth. The arbitrator may award injunctive relief, interest, and attorney fees in an equitable amount based upon the degree to which the prevailing party prevails on the merits; however, the arbitrator is not empowered to award punitive or exemplary damages. All costs of the arbitration, including the recording thereof, shall be shared equally by the parties. The arbitration proceedings and award shall remain confidential, and no party may disclose to any person, except attorneys for the parties, any aspect of the proceedings.

**WARRANTY REGISTRATION AND CONTACT INFORMATION:** The warranty registration for component parts should be completed and delivered in accordance with the instructions contained therein. The TLW registration must be completed and returned to VENTURE Recreational Vehicles within fifteen (15) days of delivery of the unit to the consumer. Failure to do so can void this TLW or cause delays in obtaining benefits. The TLW registration, and all inquiries, must be directed to: VENTURE Recreational Vehicles Warranty Department, 0985 N 900W, Shipshewana, Indiana 46565, Telephone: (260) 768-2058.

**I HEREBY ACKNOWLEDGE THAT I HAVE RECEIVED, READ, AND UNDERSTAND THIS TOWABLE LIMITED WARRANTY, AND THAT I HAVE INSPECTED THE UNIT AND FIND IT IN THE CONDITION REPRESENTED.**

Date: \_\_\_\_\_ Purchaser: \_\_\_\_\_ Model#: \_\_\_\_\_  
VIN#: \_\_\_\_\_  
Dealer Info: \_\_\_\_\_ Customer Info: \_\_\_\_\_ Name: \_\_\_\_\_  
Address: \_\_\_\_\_ Phone: \_\_\_\_\_ E-Mail: \_\_\_\_\_  
City: \_\_\_\_\_ State: \_\_\_\_\_ Zip: \_\_\_\_\_

**One year warranty coverage:**

Sonic Lite, Sonic, Sonic X, Stratus, SportTrek, and SportTrek Touring Edition.



# Table of Contents

<b>Dear Valued Customer</b>	3	<b>Traveling Weights</b>	28
<b>Limited Warranty</b>	5	Trailer Weight Information	28
<b>Important Facts/Our Valued Customer</b>	10	Weighing the Vehicle	29
<b>Contacts</b>	11	Loading Instructions	29
<b>Introduction to RV Ownership</b>	12	Loading Tips	29
Safety considerations	13	Loading the Trailer—Distribution	30
Reporting safety defects	14	Cargo Capacities	30
Safety when emergency stopping	14	<b>Tires</b>	31
Additional safety considerations	14	Understanding Tire Pressure and Loads	31
<b>Key Information</b>	15	Tire Size	32
<b>Customer Information Form</b>	16	Tire Tread	32
<b>Pre-Trip Checklist</b>	17	Tire Balance and Wheel Alignment	32
<b>Notes</b>	19	Tire Repair	32
<b>Maintenance Schedule</b>	20	Tire Speed Rating	32
<b>Maintenance Record</b>	22	How Overloading affects Tires	33
<b>Service Procedures</b>	24	How to change a Tire	33
Dealer	24	Tire Inspection	34
Factory	24	Wheel Lugs	35
Parts	24	Wheel Bearings	35
Owner Responsibility	24	Optional Spare Tire Carrier	35
<b>Towing</b>	25	<b>Electrical</b>	35
Tow Vehicle	25	Brakes-Electrical	35
Hitches—Travel Trailer	25	Breakaway Switch	36
Hook-Up (Travel Trailer)	25	Electrical System	37
The Safety Chain	26	Changes and Modifications	37
Tow Reminders	26	30 AMP Circuit Breaker in Load Center with Converter	38
Travel Trailer Un-Hook	26	50 AMP (Optional on Larger Units)	38
Trailer Setup Requirements	27	GFCI Protection	39
Setting Up and Using your RV	27	12-Volt DC System	39
		Converter and Load Center	39
		Battery Disconnect Switch	40
		Auxiliary Battery	41
		Circuit Breakers and Fuses	41



<b>Electrical Cont.</b>	42	<b>Technology</b>	49
Exterior Lights and Connector	42	Level Mate Pro	49
Porch Lights	43	USB Charger	49
Brake Wiring	43	TV Antenna—Stationary	49
Safety and General Information	43	Entertainment Components and TVs	49
Invertor	43	Monitor Panel	49
Portable Solar Receptacle Panel (Optional)	43	LCI One Control Panel	50
Solar Panel on Roof	43	iRV Panel	50
Backup Camera	43	<b>Slides</b>	51
Electrical Components	44	Slide-Out Systems	51
Monitor Panel Battery Condition	44	Slide-Out Rooms	51
Operating Switch	44	Monitor Panel: Slide Out Operation	51
<b>Detectors</b>	45	Main Floor Slides	51
What is Carbon Monoxide?	45	Below Floor Slides	51
General Detector Information	45	Above Floor Slides	51
Combo Propane and Carbon Monoxide	45	Bedroom Slides	51
Operating Instructions	45	Schwintek Wall Slide	51
Gas Alarm	46	Manual Override Access Locations	52
Simultaneous Co and Gas Alarm	46	Manual Override (Flush or Standard)	52
Carbon Monoxide Alarm	46	Manual Override (Bedroom Slide)	52
Propane Gas Alarm	46	Manual Override (Schwintek System)	52
Malfunction/Service Signal	46	Manual Override for above floor slide-out	52
Brownout Protection	47		
Low Power Operating Instructions	47		
End of Life Signal	47		
Fire Extinguisher	47		
Smoke Alarm	48		
Operating Instructions	48		
Testing	48		





<b>Tanks</b>	53	<b>Exterior</b>	68
System	53	Step Assembly	68
Tanks	53	Under Door Folding Steps	68
Monitor Panel: Water Tank Condition	53	Inside Door (Solid) Steps	68
12-Volt Demand Pump	53	Windows	69
Fresh Water Line	53	Doors	71
Low Point Drain	53	Exterior Ladder	71
Fresh Water System	54	Outside Shower (Optional)	72
Filling the Fresh Water System	54	Outside Kitchen (Optional)	72
Sanitizing and Filling Potable Water System	55	<b>Winterize Your Recreational Vehicle</b>	73
Drainage (Freshwater)	55	Extended or Cold Weather Use	73
Draining the Tanks	56	Using your Water System in Freezing Weather	73
Maintenance of Holding Tanks	56	Method #1	73
Heated Holding Tanks	56	Method #2	73
Bypass Kit	56	<b>Condensation</b>	74
Black Tank Flush System	57	Causes	74
Faucets	57	Solutions	74
Bath and Shower	57	Interior Ventilation	74
Toilets	57		
Vents	58		
<b>Fuel and Propane</b>	59		
Propane Fuel System	59		
Servicing and Filling Propane Containers	60		
Installing Propane Containers	60		
Regulator	61		
High Pressure Hoses with ACME Connectors	62		
Main Supply Hose—Low Pressure	62		
Check for Leaks	63		
Propane Gas Consumption	63		
<b>Water Heater Safety Information</b>	64		
Operating the System	64		
<b>Interior</b>	65		
Blinds	65		
Murphy Bed (Optional)	66		
Appliances	67		
Fireplace (Optional)	67		



## Important Facts

Please inspect your recreational vehicle at the time of delivery and make sure you accept it as delivered to you. This recreational vehicle has been sold to an independent dealer, and not an agent of VENTURE Recreational Vehicles, for resale in the ordinary course of the dealer's business of terms and conditions.

As equipped, you and the dealer determine your agreement solely with the dealership, not VENTURE Recreational Vehicles. VENTURE Recreational Vehicles, does not participate in retail sales or retail contracts of any instance, other than by terms of this Limited Warranty.

Using an RV in temperatures above 80 degrees or below 32 degrees F will require additional equipment to properly cool the unit or prevent freezing of the unit system and components. Additional care or preventative measures should always be exercised when using an RV in extreme weather conditions.

VENTURE Recreational Vehicles, reserves the unrestricted rights at any time to make changes in the design and/or improvements upon its products without thereby imposing any obligation upon itself to make corresponding changes in or upon its products already manufactured. VENTURE Recreational Vehicles, further reserves the right to substitute parts or components of substantially equal quality in any warranty service required by operation of the Limited Warranty.

Like any other product, a recreational vehicle and the products installed in it will require care and maintenance attention by the owner and occupants. Please read and follow all care and maintenance manuals/instructions supplied with your recreational vehicle.

**Due to continual research and advances, manufacturer reserves the right to change specifications, designs, and equipment without notice, and assumes no responsibility for any substitution in this owner's manual.**

## Our Valued Customers

If, for any reason you have a problem obtaining satisfactory and timely warranty service that may substantially impair the use, value, or safety of your VENTURE RV product, please call us so we may attempt to resolve your concerns. Authorized dealers are independent contractors and independently-owned businesses. This is also true of the authorized service centers.

**Please note: Your VENTURE RV warranty covers warrantable repairs that are performed by an authorized VENTURE RV dealer at their service center or facility. It is important for the owner to know if you are unable to bring your unit in for repairs, VENTURE RV is not responsible for any costs incurred for the service call, or time accrued.**

Can't find a dealer near you?

Have an emergency?

VENTURE RV's customer service department can be reached at **(866) 472-5460**. We can help locate a dealer nearby, or in case of an emergency, provide authorization to a local repair facility. Before using any non-authorized dealer for a warranty repair—call VENTURE RV first!



## Contacts

### NHTSA

Toll Free at 1-888-327-4236 (TTY: 1-800-424-9153)

<http://www.safercar.gov>

Administrator, NHTSA

1200 New Jersey Avenue, S.E.,

Washington, DC 20590.

### VENTURE RV

0985 N 900 W

Shipshewana, IN 46565

Phone: (866) 472-5460

Hours: (8am-5pm E.S.T.)

Email: [Customerservice@venture-rv.com](mailto:Customerservice@venture-rv.com)

Website: <http://www.venture-rv.com>

### IMPORTANT PHONE NUMBERS:

---

---

---

---

---

---

---

---

---

---



## Introduction to RV Ownership

This Owner's Manual was prepared to assist you in understanding the proper use and operation of various containment systems, servicing and maintenance of component parts, as well as, explanation of your warranty protection. If this is your first RV, you will want to acquaint yourself with all aspects and information found in this manual, including manuals supplied by component manufacturers.

These materials will reflect the most current information available for the user. Some components and items may not be in your unit as there may be various options on different models.

Keep this owner's manual in your recreational vehicle for handy reference. Get to know your new vehicle and how it operates. You should carefully read and understand these instructions, as well as information supplied by the manufacturers of separately warranted products because they contain important operating, safety, and maintenance instructions. If you have any question(s) not answered by this manual or other booklets, consult your dealer. If the dealer cannot satisfactorily answer your questions, the dealership will call our staff for additional information.

Every effort has been made to provide you with a safe and dependable product. Your vehicle complies with applicable requirements of the Federal Motor Vehicle Safety Standards, State Regulations, and Canadian Standards Association (CSA), where applicable, and complies with requirements of NFPA Standard 1192, the national Recreational Vehicle Industry Association (RVIA) and Canadian Standards Association (CSA) for those systems. Your follow-up with periodic safety inspections and a program of preventative maintenance is important for the continuation of safe and trouble-free operation.

Camping is a great way to relax and enjoy the outdoors with your family and friends. Please remember to tread lightly on our beautiful land and leave only your footprints so that others may enjoy nature as much as you do.



# Safety Considerations

The terms **WARNING**, **CAUTION**, **DANGER**, and **NOTICE** have specific meanings in this manual as well as component and vendor manuals.



## WARNING

A **WARNING** is giving notice to a user that potential injuries may occur to a person from equipment and mechanical failure. Disregarding a **WARNING** may result in serious physical injury to the occupant.



## CAUTION

A **CAUTION** emphasizes areas where equipment damage could result. Disregarding a **CAUTION** could cause permanent mechanical damage. However, personal injury is unlikely.



## DANGER

A **DANGER** alerts areas where safety measures **MUST BE STRICTLY ADHERED TO**, as such failure can be dangerous. Disregarding a **DANGER** could cause serious injury and possible loss of life.



## NOTICE

A **NOTICE** provides additional information to make a step or procedure easier or clearer. Disregarding a **NOTICE** could cause inconvenience but would not be likely to cause damage or personal injury.



## Reporting Safety Defects

If you believe your vehicle has a defect that could cause a crash, injury, or death, you should immediately inform the National Highway Traffic Safety Administration (NHTSA). If NHTSA, in addition, receives similar complaints, it may open an investigation. If they find a safety defect exists in a group of vehicles, it may order a recall and remedy campaign. However, NHTSA cannot become involved in individual problems between you, or your dealer.

For contact information to NHTSA, refer to the contact section located in the front of this manual. You can also obtain other information about motor vehicles from the hotline.

## Safety When Emergency Stopping

It is wise to purchase a carry road flares and/or triangular warning devices to be used when necessary. When pulling off a highway, use your four-way hazard lights as warning flashers. Pull off the roadway completely if possible, to change flat tires or any other emergency needs.

## Additional Safety Considerations

1. Sanitize the fresh water supply system periodically (see sanitizing instructions below).
2. Keep water connection fittings from meeting the ground or drain hose to reduce the chance of contamination.
3. Enlist services of a qualified RV Technician to test, repair, or replace propane or electrical appliances.
4. Always have a serviceable fire extinguisher placed in an accessible location.
5. Ensure tires are in good condition and properly inflated. Watch tire inflation closely. Under-inflated tires will overheat. Check the tire pressure before each trip while the tires are cold.
6. Check and tighten the wheel lugs regularly (every 50 miles when new until 200 miles are reached, then check the lugs every 500 miles).
7. Check the brakes **BEFORE** entering a busy highway, **NOT** while traveling.
8. Always block the trailer wheels solidly before unhitching.
9. Observe and obey the warning labels attached to your vehicle concerning propane, water, electricity, and loading.
10. Extinguish all campfires before leaving your campsite.
11. Before leaving a camp area with a trailer in tow, ensure:
  - A. The safety pin or locking lever is seated.
  - B. The breakaway wire is attached to the tow vehicle.
  - C. All jacks are raised so they cannot touch the ground.
  - D. The 110-volt AC electrical cord is properly stored.
  - E. The safety chains are attached to the receiver.
  - F. All interior lights are off.



**Key Information To Have On Hand (VENTURE RV Customer Should Fill Out):**

All warranty work needs to be completed during the term of the warranty.

Warranty beginning date: \_\_\_/\_\_\_/\_\_\_ Warranty ending date: \_\_\_/\_\_\_/\_\_\_

VIN# \_\_\_\_\_

**Note: All service work performed after the expiration date will not be covered by the Limited Warranty.**

**VENTURE Recreational Vehicles**

Original Owner: \_\_\_\_\_ Phone Number: \_\_\_\_\_

Dealership Purchased From: \_\_\_\_\_ Phone Number: \_\_\_\_\_

Second Owner: \_\_\_\_\_ Phone Number: \_\_\_\_\_

Person or Dealership Purchase from: \_\_\_\_\_ Phone Number: \_\_\_\_\_





## CUSTOMER INFORMATION UPDATE FORM

VENTURE RECREATIONAL VEHICLES strives to keep the most accurate and current customer information in its files in order to maintain good customer relations.

If you bought this unit new, we have your information from the warranty registration form which you have sent to us on file. If, however, you purchased this unit as used then we ask that you complete the following information and mail or email it to us at [customerservice@venture-rv.com](mailto:customerservice@venture-rv.com), so we can be sure our records are updated.

Please note the date of purchase on the registration form will show the original date the vehicle was first purchased and is the date applicable warranties originated.

**Note: The warranty on a VENTURE RECREATIONAL VEHICLES unit is on-transferable.** This customer information update form is for record keeping purposes only. If you have any questions, please contact a VENTURE RECREATIONAL VEHICLES service representative.

DATE: \_\_\_\_\_ UNIT VIN NO: \_\_\_\_\_

CUSTOMER FULL NAME: \_\_\_\_\_

CUSTOMER ADDRESS: \_\_\_\_\_

TELEPHONE NUMBER: \_\_\_\_\_

EMAIL ADDRESS: \_\_\_\_\_

PURCHASED FROM: \_\_\_\_\_

ADDRESS: \_\_\_\_\_

**VENTURE RECREATIONAL VEHICLES**  
**ATTN: Customer Service**  
**985 N 900 W**  
**Shipshewana, IN 46565**  
**Phone: (866) 472-5460**  
**Email: [customerservice@venture-rv.com](mailto:customerservice@venture-rv.com)**





## Pre-Trip at Home Checklist

### Exterior:

- All objects are secure \_\_\_\_\_
- Awnings locked \_\_\_\_\_
- Tires at proper pressure (including spare) \_\_\_\_\_
- Wheel lug nuts tightened to proper torque \_\_\_\_\_
- Hitch and/or pin box secured properly \_\_\_\_\_
- All exterior lights are operational \_\_\_\_\_
- Battery is fully charged \_\_\_\_\_
- Fluid levels good \_\_\_\_\_
- Brakes checked for operation \_\_\_\_\_
- Secure cargo and lock compartment doors \_\_\_\_\_
- Under-carriage items secure \_\_\_\_\_
- Slide rooms are sealed tightly when closed \_\_\_\_\_

### Interior:

- Antenna lowered \_\_\_\_\_
- Roof vents lowered \_\_\_\_\_
- Refrigerator locked \_\_\_\_\_
- Water heater off \_\_\_\_\_
- Water pump off \_\_\_\_\_
- Fresh water tank level \_\_\_\_\_
- Waste water tank level \_\_\_\_\_
- Toilet operational \_\_\_\_\_
- Furnace off \_\_\_\_\_
- LP gas system checked \_\_\_\_\_
- Cooktop cover closed \_\_\_\_\_
- Drawers, Closets, and Windows closed \_\_\_\_\_
- Television swivel trays locked \_\_\_\_\_



**(At Campsite)**

**Follow the previous checklist with these added points!**

**Exterior:**

Disconnect all shorelines: \_\_\_\_\_

Hook up tow vehicle: \_\_\_\_\_

Remove wheel chocks: \_\_\_\_\_

Retract step: \_\_\_\_\_

Store camping equipment: \_\_\_\_\_

**Check clearances prior to pulling out!**

This checklist may seem like it contains basic items, but many are taken for granted and can spoil a trip if not attended to prior to moving the trailer.

You may want to use this list as a start for your own Pre-Trip checklist, which may include your personal camping gear and food preferences.

**Items to Carry:**

- An emergency road kit and flashlight.
- An assortment of spare fuses.
- An assortment of hand tools.
- 12 Volt DC test light may be helpful when speaking with a technician.
- A battery hydrometer to check the condition of the battery electrolyte.
- Polarity tester to check 120 AC outlets.
- Potable/non-potable water hoses and a water pressure regulator.





## MAINTENANCE SCHEDULE

*Tighten wheel bolts or nuts every 50 miles for the first 200 miles & after every change in wheel mounting. (Torque to 90-120 ft.-lbs.) Adjust brakes after first 200 miles then at above listed intervals	INSPECT/ TEST BEFORE EACH TRIP	MONTHLY	EVERY 3 MONTHS	EVERY 6 MONTHS	YEARLY	AS REQUIRED BY MANUFACTURER
Axle and springs	X			X		
Batteries	X			X		
Water level	X			X		
Brakes	X			X	X	
Exterior lighting	X				X	
Fresh water system	X				X	
Have all appliances serviced						X
LP gas system	X					
Pigtail connection	X				X	
Roof sealant			X			
Roof vents			X			
Safety breakaway switch operation	X				X	
Sidewall sealants			X			
Tire lug nuts (after initial 500 mile check)	X					
Tires (condition and pressure)	X					X
Underbelly, check for tears or leaks				X		
Wheel bearings				X		X
Seals – doors, windows, vents, external seams			X			
Clean exhaust fan filter and blades			X			
Test smoke alarm and LP detector	X					
Check operation of windows, latches and hinges			X			
Clean the roof ducted air conditioner filter(s)			X			
Inspect and reseal shower area, where necessary			X			
Lubricate exterior door hinges and latches with a graphite (silicone) lubricant			X			



## MAINTENANCE SCHEDULE

*Tighten wheel bolts or nuts every 50 miles for the first 200 miles & after every change in wheel mounting. (Torque to 120-125 ft.-lbs.) Adjust brakes after first 200 miles then at above listed intervals	INSPECT/ TEST BEFORE	MONTHLY	EVERY 3 MONTHS	EVERY 6 MONTHS	YEARLY	AS REQUIRED BY MANUFACTURER
Check, clean and tighten battery cables			X			
Rotate tires, as recommended by the tire manufacturer						X
Check all appliances for proper operation	X			X		
Have the heat and ignition inspected by a qualified technician				X		
Inspection of roof seams and joints (performed by an authorized service center suggested)				X		
Sanitize the fresh water system	X				X	
Wax and buff all gel-coat surfaces (as described in owner's guide – where applicable)					X	







# Service Procedures

VENTURE and your dealer have a strong and dedicated interest in maintaining the highest quality customer relations with its owners. In addition to producing high-quality products, we want to assure our customers of our support with parts and service availability. Our dealer network is the first choice to serve and supply your needs for your recreational vehicle. Our authorized dealers will assist you in providing service maintenance needs plus parts, options, and information concerning your recreational vehicle.

Should you experience a problem with service availability, please follow these steps in the order listed:

1. Contact your selling dealer's service department for an appointment. Describe, to the best of your knowledge, the nature of the problem. Please keep appointments to establish a good, workable relationship.
2. Contact the owner or general manager of the dealership should the initial attempt fail with the service department.
3. Contact: VENTURE Customer Relations Department at **(866) 472-5460**.

Give all the above information as requested, along with the VIN number of the unit in question. We will make every attempt to resolve your problem(s). Please bear in mind most problems arise from misunderstandings concerning the warranty coverage and service. In most instances, you will be referred to the dealer level and your concerns will be resolved with the dealer's facility and personnel.

## Dealer

Your authorized dealer has performed a PDI (pre-delivery inspection) on your recreational vehicle. Since your dealer is authorized to sell products, they are also there to supply parts, optional equipment, and provide service repairs, warranty, etc. as needed. The first choice for your warranty repairs is your selling dealer. Other dealers can be used, however, prior approval is required.

Some recreational vehicle dealers may be authorized service centers for certain manufacturers of products warranted separately. Check with your dealer before contacting anyone else to reduce delays. If the dealer is not an authorized service center for the product in question, they can assist you in obtaining authorized service.

## Factory

Service repairs can be performed at the manufacturing facility in Shipshewana, Indiana. Should your product need major repairs and your dealer recommends factory repairs, please use the following steps to ensure repairs:

1. Your dealer must make an appointment with the service personnel at the factory **PRIOR** to your arrival.
2. Fill out in their entirety, all VENTURE supplied forms and return them to VENTURE.
3. Any freight costs are the responsibility of the owner, as listed in the warranty coverage schedule.

## Parts

Stocking of parts varies from dealer to dealer. Any authorized dealer can order any required part to be shipped to their dealership.

## Owner's Responsibility

As an owner and operator, it is your responsibility and obligation to inspect and return your unit to an authorized dealer for repairs. Your authorized selling dealer is always your first choice and they certainly have continued interest in your satisfaction. As your manufacturer, we recommend inspection and service be performed by your selling dealership.

When owning and using a recreational vehicle, it is important to perform regular and normal maintenance. This is recommended twice a year, spring and fall, to prevent undesired deterioration of your recreational vehicle. Weather elements play an important function on sealants and other components requiring routine maintenance.

If you are traveling and are unable to locate an authorized dealer or an authorized dealer for the component needing service, please call our customer service line at **(866) 472-5460**. Service at a non-authorized dealer **MUST** have prior authorization. You may be asked to return any replaced mechanical parts before reimbursement consideration is made. Unauthorized or improper repairs may void the warranty of that component. **Always keep your owner's manual in your unit, along with a copy of your warranty registration when traveling.**





# Towing

## Tow Vehicle

Begin your camping experiences by obtaining a tow vehicle that will adequately transport your recreational vehicle to and from your chosen destination. Your most important measuring tool is the GVWR (Gross Vehicle Weight Rating), to cross-match the capability of your selected tow vehicle. All units are weighed on a scale before being shipped. Most auto and truck manufacturers provide trailer towing guides for their products. Ask your local automotive dealer for a copy or call the factory's direct lines for information. Many tow vehicles, including minivans, have special towing package options available for small travel trailers. Towing vehicles with long wheelbases perform better than those with short wheelbases. A second factor is GCWR (Gross Combined Weight Rating), which refers to the total weight of the tow vehicle and any vehicle in tow as a "combined" weight. The information, supplied by the tow vehicle manufacturer, is related to the capability of the tow vehicle.

The condition of the suspension on your tow vehicle is also an important factor. Make sure your tow vehicle is in good operating condition and follow the factory recommended maintenance guidelines as this will affect your towing performance.



## CAUTION

**Trailers with tandem axles need to travel as level as possible, avoiding different weights on each axle plus handling conditions. Using an oversized or undersized hitch can cause damage to the frame of your travel trailer and/or tow vehicle.**

### Hitch Height Specifications -Travel Trailer

Due to axles being either straight or drop bar, the ball height will vary. To find the correct height for the ball hitch, set your trailer on a flat and level surface in level position. Measure from the inside of the ball socket to the ground, approximately 18 to 22 inches, for correct spacing. You may wish to add 1 to 2 inches to this amount to compensate for the sag of suspension of the towing vehicle when hooked to the RV.

## Hitches – Travel Trailer

After obtaining your tow vehicle, it is very important to choose, and have installed, a correct hitch system with weight distributing bars to accommodate your unit if required. This selection and installation should be done by a professional hitch service center, which may or may not be your selling dealer. Sway controls may be needed based on the size and weight of the unit, plus the capability of your tow vehicle.

### Hook-Up

Hooking up the travel trailer can be a simple task with practice. The following procedure will help you become familiar with various parts:

1. To raise the tongue of the trailer above the hitch ball, turn the crank on the jack or use a 12-volt DC option by pushing the button. Use 12-volt power through the tow vehicle to the recreational vehicle battery, for assistance, if needed.
2. Open the coupler latch.
3. Back the tow vehicle into proper position, the coupler over the ball.
4. Turn the crank on the jack to lower the coupler onto the ball hitch.
5. Close the coupler latch after completely seated. To secure the coupler latch, it is recommended that you install a lock.
6. Install weight distributing bars (equalizer), when required, as recommended by hitch supplier.
7. Fasten safety chains to the frame of the tow vehicle. **DO NOT** fasten chains to any part of the hitch unless the hitch has holes or loops specifically for that purpose. Cross the chains underneath the hitch and coupler with enough slack to permit turning and to hold tongue up if the trailer comes loose.
8. Connect the breakaway switch cable to the tow vehicle, making sure it is not attached to any part of the trailer.
9. Crank the jack all the way up.
10. Pull forward and check the operation of the trailer brakes.



## The Safety Chain



Safety chain requirements will vary from state to state. The chain supplied with your unit meets SAE requirements for maximum gross trailer weight.

1. Cross the left chain under the coupler and attach to the right ring on the hitch receiver of the tow vehicle.
2. Take the right chain under the coupler and attach it to the left ring on the hitch receiver of the tow vehicle.

### Listed are items to be inspected and tested before travel.

- All external lights are in working condition.
- Stabilizer jacks are in the retracted position.
- Steps are in the retracted position.
- The refrigerator door is latched.
- Loose items are secured.
- Test brakes before operation onto the roadway.
- Test each smoke alarm weekly to be sure it is installed and operating correctly.

## Towing Reminders

In towing the trailer recognize the extra weight behind the vehicle. Below is a list of observations to remember while traveling:

1. With the trailer attached, there will be slower acceleration and require more distance to stop.
2. Be sure to have enough area at corners when turning, as wider turns are necessary.
3. When passing or changing lanes, remember you will need a longer distance to pass.
4. Use your rearview mirrors frequently to observe the trailer and traffic conditions.
5. When being passed by a large truck or bus, be prepared for displaced air as it may cause the unit to sway slightly, especially with travel trailers.
6. When climbing steep, long grades, and descending, use lower gears even before it seems necessary. Use brakes smoothly and evenly.
7. Remember to drive slower on wet pavement and icy highways to keep control of the vehicle.

## Travel Trailer Un-Hook

1. Release the weight distributing bars (if used).
2. Release the safety latch on the coupler.
3. Raise the coupler on the A-frame by turning the tongue jack until the ball is free.
4. Disconnect the 7-way wire connector, safety chains, and the breakaway cable.
5. Raise the front tongue jack until the coupler will clear the hitch ball. Drive the tow vehicle away.
6. Now raise/lower the front end until the unit is level front to back.
7. Lower the stabilizer legs to the desired position to stabilize the unit.
8. Reverse the procedure to hook up the unit to a tow vehicle.



Upon completing the setup of your unit, you are now ready to make attachments to various facilities:

- Waste water hose connections.
- 110-volt power cord electrical hookup.
- Turn on propane tanks and light the pilot lights, if any, on appliances. Remember there may be air in your propane lines. Be sure to bleed them before planned usage.
- Open any windows and roof vents, as desired, for ventilation.
- Fresh water connections.

You may have additional accessories and options. Separate instructions are provided by the manufacturer of these components.

## Travel Trailer Un-Hook

1. Release the weight distributing bars (if used).
2. Release the safety latch on the coupler.
3. Raise the coupler on the A-frame by turning the tongue jack until the ball is free.
4. Disconnect the 7-way wire connector, safety chains, and the breakaway cable.
5. Raise the front tongue jack until the coupler will clear the hitch ball. Drive the tow vehicle away.
6. Now raise/lower the front end until the unit is level front to back.
7. Lower the stabilizer legs to the desired position to stabilize the unit.
8. Reverse the procedure to hook up the unit to a tow vehicle.

## Precautions

1. Be sure to park the unit on solid ground.
2. Be sure the tires are blocked and the unit cannot roll.
3. Be sure people and pets are away from the camper.
4. Be sure to park on level ground, if possible.
5. **DO NOT** lift the unit off the ground with any landing legs or stabilizer legs, front or rear.

The use of stabilizer legs on a recreational vehicle is a popular and useful option. They provide a reasonable amount of stability while using, occupying, and moving around in the camper. It is important to remember stabilizer legs are for support of the unit and are **NOT** designed to bear the weight of a recreational vehicle.

To operate the stabilizer legs, place the crank onto the jack shaft and turn clockwise to lower until the frame begins to rise slightly. Equalize all four legs for the best support. You may need to adjust each leg two or three times. To raise the leg to the upper travel position, insert the crank and turn counterclockwise until the leg is seated in the up travel position.

## Setting Up and Using Your Recreational Vehicle

As the manufacturer, we recommend you select a level or nearly level place for camping. There are two reasons to be level:

1. All components in the unit, such as the water drainage system and especially the refrigerator, are designed to operate in a level position.
2. Should a level site not be available, use a short 2 x 6-inch block of wood to raise the low side wheels to a level position. Before unhooking the trailer from the tow vehicle, be sure the leg foot is in place on the tongue jack and block the trailer wheels to keep the trailer from moving. Before lowering the landing leg, you may wish to place a woodblock or hard support under the foot of each leg, unless you are on a cement slab. This helps to prevent the legs from sinking into the ground.

**NOTE: VENTURE does NOT require or suggest using any blocking or supports, jacks, etc. to be used under any slide assembly during extended use as the water seals on the walls and roof won't be sealed tight. Before operating the slide out room, level the trailer front-to-rear and side-to-side. Extend all stabilizer jacks to make solid contact with the ground and/or on solid blocks. Placing stabilizer jacks onto a hard surface allows the unit to remain square and assure a good weather tight seal between the room and trailer sidewall.**



# Traveling Weights

For safety reasons and federal regulations, VENTURE provides accurate weight specifications to owners. On the exterior left front corner of the unit, you will find the federal “Vehicle Information Number” sticker, as required by the federal government.

This tag supplies information concerning your unit, such as; VIN number, date/month of manufacture, tire size rating, and information regarding weights as described in this manual.

**Gross Axle Weight Rating (GAWR)** – This is the value specified as the load carrying capacity of a single axle system, as measured at the tire-ground interfaces. The tires will be rated 10% higher than the axle.

**Gross Vehicle Weight Rating (GVWR)** – This is the maximum permissible weight of the trailer when fully loaded. This includes all the weight at the trailer’s axle(s) and tongue or pin on a fifth wheel. This includes all cargo, options, and liquids.

**Unloaded Vehicle Weight (UVW)** – This is the weight of the trailer as manufactured in the factory. This includes all weight at the trailer’s axle(s) and tongue. If applicable, it also includes full generator fluids, including fuel, engine oil, and coolants.

**Cargo Carrying Capacity (CCC)** – This is equal to the GVWR minus each of the following: UVW, full fresh (potable) water weight (including water heater and full propane weight).

*To determine how many pounds of personal cargo you may carry, use the following formula:*

**Cargo Carrying Capacity (CCC) computation**

GVWR \_\_\_\_\_  
 Minus UVW \_\_\_\_\_  
 Minus Fresh Water Weight of \_\_\_\_\_ gallons @ 8.3lb/gal  
 Minus LP-Gas weight of \_\_\_\_\_ gallons @ 4.2lb/gal

## Recreational Vehicle Trailer Carrying Cargo Capacity

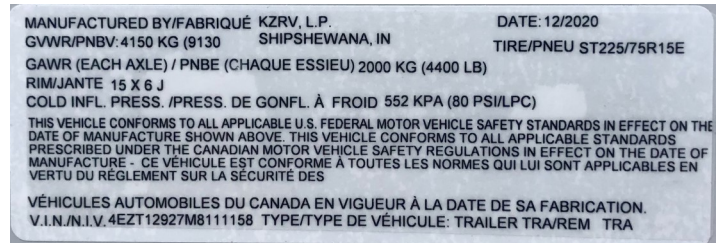
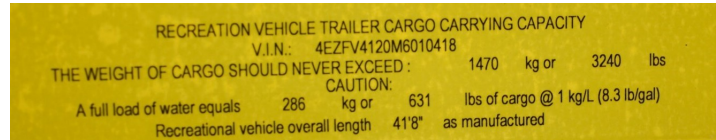

## Trailer Weight Information

The certification label will indicate the gross vehicle weight rating (GVWR). This is the most weight the fully loaded vehicle can weigh. It will also provide the gross axle weight rating (GAWR). This is the most weight an axle can carry. If there are multiple axles, the GAWR of each axle will be provided.

**\*Dealer installed equipment will reduce CCC\***

Consult the owner’s manual(s) for specific weighing instructions and towing guidelines.

It is important to evaluate all guidelines to calculate the “Cargo Carry Capacity” of your unit. Find the weights of the unit on a sticker, placed on the edge of the screen door. This will enable you to determine the “CCC” in the different areas of the unit.

For best traveling , while towing an RV, it’s important to have the trailer and tow vehicle as level as possible.



## Weighing the Vehicle (Loaded or Unloaded)

The proper method of weighing the unit is to use a truck scale. Place the unit axles (tires) and tongue jacks 12" to 24" away from the edge. Unhook the tow vehicle and move forward off of the scale. Record the total weight. Re-hook the tow vehicle and pull forward until the rear axle of the tow vehicle is no longer on the scale. Be sure no part of the tow vehicle is on the scale. Only record the axle weight. The difference between the two weights is the hitch weight.

It is suggested you also weigh each side (2 tires) separately to find the balance of pounds per side. It is possible to have 1 side correct and the other side overloaded. Often, the slide side or the refrigerator side, will be heavier than the other side.

The second sticker is the "Trailer Weight Information", which is located on the inside screen entry door. This gives the Hitch Weight, UVW, and CCC.

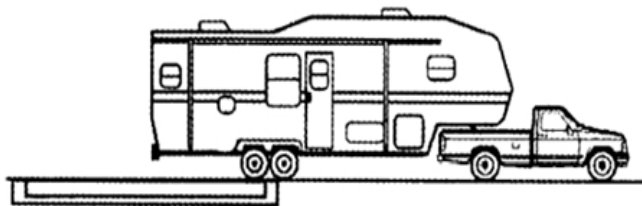
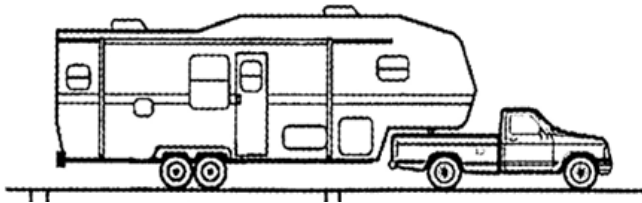

## Loading Instructions

The first thing you are going to do before leaving for a trip is load such items as food, clothing, bedding, and recreational equipment. As you become more experienced in RV living, you will learn what is necessary and what takes up most of your storage space.



## NOTICE

**Empty all holding tanks before filling the fresh water tank; otherwise, you will limit your cargo capacity. Most campgrounds supply dump stations which should be utilized.**

## Loading Tips

Load the RV and distribute the load so that you get proper weight on the axles and hitch. **DO NOT** load the upper cabinets with heavy items that can shift or fall during transit. Secure and brace items so they won't move during travel. **DO NOT** load heavy items near either end of the RV or on the rear bumper. Adjust any cargo storage to keep the side to side wheel loads as equal as possible. Carry only as much water as needed for travel use or to balance the load. **ALWAYS EMPTY YOUR WASTE WATER AND SEWAGE HOLDING TANKS BEFORE TRAVELING.**

Store emergency items in a readily accessible location. Include tools, first-aid kit, rain gear, flashlight, highway warning devices, and an electric cord or light.

All items must be considered for their weight and stored according to how heavy they are. Heavy items should be placed close to the floor and in the center of the vehicle. **DON'T FORGET TO INCLUDE THE ITEMS YOU PURCHASE ON YOUR TRIP.**

Luggage and similar cargo carried inside the vehicle **MUST** be secured to prevent possible damage in the case of a sudden stop or accident.



## Loading the Trailer—Distribution

As per the manufacturer, VENTURE does not restrict what cargo is carried, providing weight limits and capacities are not exceeded, and distribution of weight is performed as listed in this manual. Non-compliance may affect warranty coverage due to overweight and improper handling during travel.

A reasonable principal in loading the unit is for every two pounds of weight loaded in front of the axle, one pound of weight must be loaded behind the axle. Also remember, improper side-to-side loading affects leaf spring condition. **Ultimately it is your responsibility to load the unit properly.**

The excess weight behind the axles lightens the hitch weight and will tend to magnify any sway and “fishtailing” that may occur when passing trucks or when gusty winds are present. Uncalculated weight can and will affect road performance.

When using a weight distributing hitch and equalizer bars, you may move/transfer hitch weight from the unit to the tow vehicle assisting with level towing and easier travel.

Items in the cargo area **MUST** be secure and/or loaded in the floor as close to the axles as possible. **Don't forget**, cargo behind the axles will bounce, shift, and move more than cargo in the front of the axles.

Lightweight and bulky items such as paper products, bedding, clothing, etc., should be stored in overhead cabinets and closets. Heavy items such as cooking utensils should be placed in lower cabinets. Canned goods need to be stored in a pantry if so equipped or in lower cabinets. Also, heavy items should be secured to avoid shifting during travel.

## Cargo Capacities

Determining the load limits of a vehicle includes more than understanding the load limits of the tires alone. Cargo can be added to the vehicle, up to the maximum weight specified on the place card. The combined weight of the cargo is provided as a single number. In any case, remember, the total weight of a fully loaded vehicle cannot exceed the certification label.

Water and propane also need to be considered. The weight of a fully filled propane container is considered part of the weight of the RV. Water, however, is a cargo weight and is treated as such. If there is a freshwater storage tank of 100 gallons, the tank when filled would weigh about 830 pounds. If more cargo is being transported, water can be off-loaded to keep the total amount of cargo added to the vehicle within the limits of the GVWR so as not to overload the vehicle. Understanding this flexibility will allow the owner to make choices that fit your travel and camping needs.

When loading cargo, be sure it is distributed evenly to prevent overloading front to back and side to side. Heavy items should be placed low and as close to the axle positions as reasonable. Too many items on one side may overload a tire. The best way to know the actual weight of the vehicle is to weigh it on a public scale. Talk to your local dealer to discuss the weighing methods needed to capture the various weights related to the RV. This would include weights for the following: axles, wheels, hitch or pin (in the case of a trailer), and total weight.



# Tires

All towable units are equipped with appropriate tires for recreational vehicles. Tires are rated to carry weight as listed on GVWR specifications. Tires are radial in design, using components to offer excellent strength and mileage in all kinds of weather conditions.

On the left front, exterior corner of the unit, is the (VIN) label along with a placard, supplying information on tires such as tire size and amount of air pressure (maximum).

Tires are one of the most important components of the towing package. Taking care of tires during travel is very important. At the top of the list is maintaining correct air pressure and secondly is **NOT** overloading the RV.

**NOTE: The sticker on the exterior of the unit is information regarding the tire size and air pressure, related to your specific unit.**

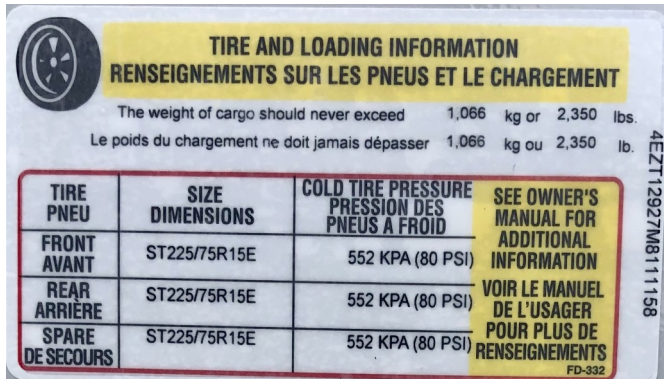

**TIRE AND LOADING INFORMATION**  
**RENSEIGNEMENTS SUR LES PNEUS ET LE CHARGEMENT**

The weight of cargo should never exceed 1,066 kg or 2,350 lbs.  
 Le poids du chargement ne doit jamais dépasser 1,066 kg ou 2,350 lb.

TIRE PNEU	SIZE DIMENSIONS	COLD TIRE PRESSURE PRESSION DES PNEUS A FROID	SEE OWNER'S MANUAL FOR ADDITIONAL INFORMATION VOIR LE MANUEL DE L'USAGER POUR PLUS DE RENSEIGNEMENTS
FRONT AVANT	ST225/75R15E	552 KPA (80 PSI)	
REAR ARRIERE	ST225/75R15E	552 KPA (80 PSI)	
SPARE DE SECOURS	ST225/75R15E	552 KPA (80 PSI)	

4E2T12927M0111158  
FD-332



## CAUTION

**It is recommended the tire pressure be checked at the beginning of each journey and at least once per week during travel to obtain the maximum life of the tires.**

With proper care, the performance of fuel economy and handling on the road will be better. Both stickers, VIN and TIRES are permanently attached to the trailers left front corner of the exterior and easily readable from the outside of the vehicle without removing any covers.

**DUE TO WEATHER-RELATED ELEMENTS, LABELS MAY FADE OVER TIME. RECORD THIS INFORMATION AND KEEP IT WITH THE OWNER'S MANUAL INSIDE THE UNIT.**

# Understanding Tire Pressure and Load Limits

Tire inflation pressure is the level of air in the tire that provides it with load carrying capacity and affects the overall performance of the vehicle. The tire inflation pressure is a number that indicates the amount of air pressure measured in pounds per square inch (psi), a tire requires to be properly inflated. This number is on the vehicle information placard and is expressed, also in kilopascals (kPa) which is the metric measure used internationally.

The recommended tire inflation pressure that vehicle manufacturers provide reflects the proper psi when a tire is cold. The term cold does **NOT** relate to the outside temperature. Rather, a cold tire is one that has not been driven on for at least 3 hours.

Excessive loads and/or inflation cause tire overloading and, as a result, abnormal tire flexing occurs. This situation can generate an excessive amount of heat within the tire and brakes. Excessive heat may lead to tire failure.

The listed amount of air pressure is for maximum load capacity. When traveling with less than full weight, you may wish to reduce air pressure slightly for a smoother ride. While driving, tires will get warmer, causing air pressure to rise. To get an accurate pressure reading, allow tires to cool for at least 3 hours. For convenience, purchase a good quality pressure gauge to keep in the tow vehicle. Gauges can be purchased at an auto parts store.

Since tires are designed to be used on more than one type of vehicle, tire manufacturers list the "maximum permissible inflation pressure" on the tire sidewall. This number is the greatest amount of air pressure that should ever be put in the tire under normal driving conditions.

If you have been driving your vehicle and think a tire is under-inflated, fill it to the recommended cold inflation pressure indicated on your vehicle's tire information placard or certification label. While the tire may still be slightly under-inflated due to the extra pounds of pressure in the warm tire, it is safer to drive with air pressure slightly lower than the vehicle's manufacturer's recommended cold inflation pressure than to drive with a significantly under inflated tire. Since this is a temporary fix, don't forget to recheck and adjust the tire's pressure when you can obtain a cold reading.



## Tire Size

To maintain tire safety, purchase new replacement tires that are the same size and load rating as the original tires, or another recommended by the manufacturer. Look at the tire information placard or on the sidewall of the tire you are replacing, to find this information. If you have any doubt about the correct size to choose, consult with the dealer. "ST" tires are **NOT** automotive tires!

## Tire Tread

The tire tread provides the gripping action and traction that prevents your vehicle from slipping or sliding, especially when the road is wet or icy. In general, tires are not safe and should be replaced when the tread is worn down to 1/16 of an inch. Tires have built-in tread wear indicators that let you know when it is time to replace your tires. These indicators are raised sections, spaced intermittently on the bottom of the tread grooves. When they appear "even" with the outside of the tread, it is time to replace your tires.

## Tire Balance and Wheel Alignment

Since it is **NOT** legal to ride inside of an RV, except fifth wheels in most states, it is rare a trailer tire requires to be balanced. Balance is achieved by positioning weights on the wheel to counterbalance heavy spots on the wheel and tire assembly using a balance machine.

Tires are not balanced on the unit, nor is it required. You may choose to balance the tires. A wheel alignment adjusts the angles of the wheels, so they are positioned correctly "toe-out/in and camber" relative to the frame of the trailer. Both of these will maximize the life of your tires.

These adjustments require special equipment and should be performed by a qualified and fully trained technician. These 2 items are **NOT** covered by warranty.

## Tire Repair

The proper repair of a punctured tire requires a plug for the hole and a patch for the area inside the tire that surrounds the punctured hole. Punctures through the tread can be repaired if they are not too large, but punctures to the sidewall should not be repaired. Tires must be removed from the wheel to be properly inspected before being plugged and patched.

## Tire Speed Rating

Please note that the maximum load rating, tire pressure, and speed rating are imprinted on the sidewall of the tire.

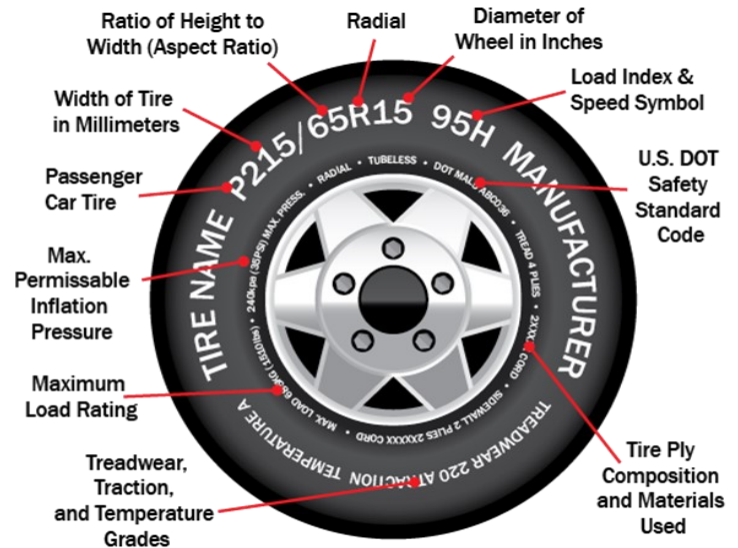

Federal law requires tire manufacturers to place standardized information on the sidewall of all tires. This information identifies and describes the fundamental characteristics of the tire and provides a tire identification number for safety standard certification and in case of a recall.

On each tire is a serial number, beginning with DOT, 4 letters or numbers giving the location of the manufacturing plant and the date of manufacture, 0820 says it was built the 8<sup>th</sup> week of 2020. A considerable quantity of information is built into the sidewall of a tire, such as the date of manufacture, size, weight limit the tire can carry, air pressure, serial number, and where it was built.





## How Overloading Affects Tires and your RV

The results of overloading can have serious consequences for passenger safety. Too much weight on the vehicle's suspension system can cause spring, shock absorber, brake failure, handling or steering problems, irregular tire wear, and tire failure.

When towing an overloaded vehicle, it is harder to drive, steer, and stop. In cases of serious overloading, breaks can fail completely, particularly on steep hills. The amount of weight a tire will carry safely is a combination of the size of the tire, its load range, and its corresponding inflation pressure.

Air pressure enables a tire to support the load of an RV, so proper inflation is critical. Since RV's can be configured and loaded in many ways, air pressure must be determined from actual loads (determined by weighing) and taken from the load and inflation tables provided by the tire manufacturer. If you discover that your tires cannot support the actual weights, the weight of the load will need to be reduced.

**NOTE: TIRES ARE WARRANTED BY THE MANUFACTURER OF THEIR RESPECTED BRAND AND ARE TO BE SERVICED BY A TIRE SERVICE CENTER.**

## How to Change a Tire

1. Be sure the unit is solid and will **NOT** move with the tire and wheel off.
2. Place blocking under the main rail/frame with a hydraulic leg on top of the blocking in front of the spring hanger, **ALWAYS** on the main rail.
3. Break lug nuts loose before raising the unit. **DO NOT** remove the nuts.
4. Raise the unit with the jack until the tire is off the ground.
5. Place additional blocking under the frame for security support. **DO NOT** depend on the jack only.
6. Remove the lug nuts when the tire is off the ground.
7. Place the spare tire and wheel onto the hub.
8. Reinstall the lug nuts and tighten them firmly.
9. Drop the tire and wheel onto the ground after removing the supports.
10. Fully tighten and torque the lug nuts to 120-foot pounds.
11. Place all equipment into the unit or tow vehicle (blocking and jack).
12. Re-torque the wheel bolts or nuts every 50 miles for the first 200 miles and after every change in wheel mounting.



## Tire Inspection

The following chart is meant to be helpful in determining the condition and maintenance of your RV tires:

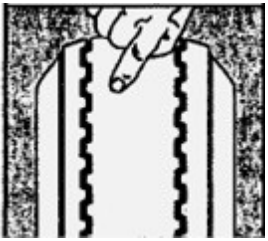
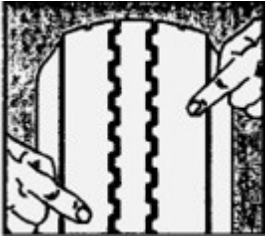
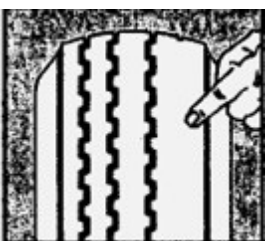
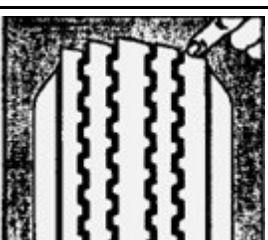
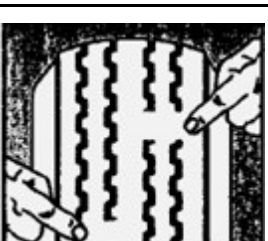
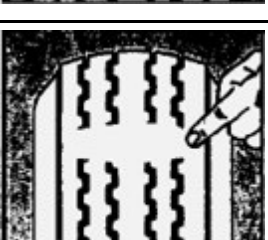
	<b>Condition</b>	<b>Possible Cause</b>	<b>Remedy</b>
	<b>Even Center Wear</b>	<b>Over Inflation</b>	<b>Check &amp; Adjust Pressure When Cold</b>
	<b>Inside &amp; Outside Wear</b>	<b>Under Inflation</b>	<b>Check &amp; Adjust Pressure When Cold</b>
	<b>Smooth Side Wear – One Side</b>	<b>Loss of Camber or Overloading</b>	<b>Check &amp; Unload As Necessary Have Alignment Checked</b>
	<b>“Feathering” Across The Face</b>	<b>Axle Not Square To Frame or Incorrect Toe In</b>	<b>Square Axles Have Alignment Checked</b>
	<b>Cupping</b>	<b>Loose Bearings or Wheel Balance</b>	<b>Check Bearing Adjustment and Wheel &amp; Tire Balance</b>
	<b>Flat Spot</b>	<b>Wheel Lockup</b>	<b>Adjust Brakes</b>



## Wheel Lugs

When the wheels are installed onto your recreational vehicle, the lug nuts must be tightened at 120-foot pounds of torque. Powder coat painted wheels may require more torque attempts due to the thickness of the paint. Re-torque the wheel lugs at 50 and 200 miles when new. A decal on the wheel may require torque earlier. After the first trip, check the wheel lugs periodically for safety. The wheel lugs should then be checked after winter storage, before starting a trip, or following extensive braking. The size of the bolts or nuts is 13/16 inch standard and 3/4 inch for a chrome nut. Over torque will damage components especially if torque wheel lugs go over 150 pounds. Normally the “nut” fails first, however, the embossing on the wheel can also be flattened, and then fail to keep the wheel tight.

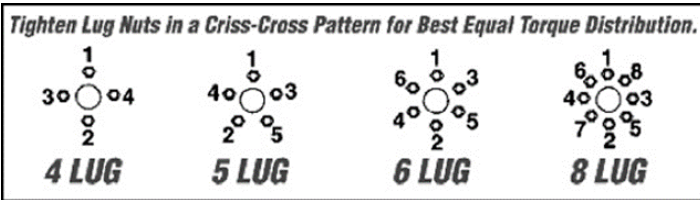

## Wheel Bearings

All wheel bearings are pre-lubricated during the assembly of the axle and brakes. The unit may have the “ULTRA LUBE” method of having a grease fitting at the end of the axle. Remove the rubber cap on the end of the axle and use a standard grease gun to place grease into the bearings, 6 to 10 shots. Repack bearings as per the maintenance manual.

## Optional Spare Tire Carrier



Many owners desire to have a spare tire and wheel for emergencies. On some models, the spare is carried under the floor behind the axles, a steel bracket holds the spare with a cable. A hoist is attached to the floor, the cable drops down through the cover. A rod is attached to the hoist with a 3/4” nut that is welded to it, this is the means to raise and lower the spare. Turning clockwise will raise the spare, and turning counterclockwise will lower it. Use a 3/4” socket, extension, and ratchet to operate. The hoist is enclosed and not visible.

## Electrical

### Brakes – Electrical

Electric brakes on the recreational vehicle are designed to work in conjunction with the hydraulic brakes on the tow vehicle. This means to have the best break performance on both systems, the trailer and the tow vehicle must perform and operate together. Any attempt to use either brake system alone, tow vehicle or trailer, will cause accelerated wear and damage.

The battery in the tow vehicle is the primary source of power to operate the brake system in the towable trailer. Keep the battery and charging system in good working condition to ensure available power when required. A brake control is required to be installed on the tow vehicle to operate the brake system, using 12-volt DC power. Each brand has its own operating instructions. Power from the battery is sent to the controller, the “switch” to provide the correct amount of current to the brake assemblies on the unit. As you press harder on the pedal, more current will flow, applying more brakes, increasing braking capability.

Wiring to operate the brakes must be sized correctly in both vehicles, suggesting a minimum of 14 gauge from the tow vehicle to the trailer brake assemblies. Wiring is done parallel, never in series. Being parallel, there will be equal voltage at each brake assembly for equal braking capability and performance.

Use the foot pedal in the tow vehicle to control breaking for general operation and combined use of both brake systems. Manual control is to be used only in special situations, such as slow movement or icy road conditions. In the open position, electrical current will flow to brake assemblies, activating them.

When applying brakes to stop the trailer, begin pressing slowly to avoid a quick and sudden stop, or possible “jack-knife” when wet or slippery conditions exist. Use lower gear ranges to minimize the need for brakes during extended or steep down grades. Remember to drive slower on wet and icy highways to keep control of your vehicle.

The unit may have self-adjusting brake assemblies to correct any looseness in operation as they will self-adjust in forward or backward motion as soon as towing begins.



## Breakaway Switch



The battery in the tow vehicle is the primary source to operate the brake system in a towable trailer. The battery in the tow vehicle is the primary source to operate the brake system in a towable trailer. The breakaway switch is the safety part of your trailer's electrical brake system. This system will apply the brakes of the trailer should it become loose or detached from the tow vehicle. Keep the battery and charging system in good working condition to ensure available power when needed. A 12-volt battery must be installed on the trailer to power the breakaway switch. This is required by law in many states. Condition to ensure available power when needed. A 12-volt battery must be installed on the trailer to power the breakaway switch. This is required by law in many states.

Each state has its own laws concerning this component. Never use this breakaway switch and trailer brake system as a parking brake. There would be a high amp draw on the battery and converter, potentially causing damaged wiring, connectors, and the breakaway switch plus unnecessary energy draw. When the plunger is pulled with the power engaged, there is a constant 12-volt draw on the energy source to the brake assembly.

**THIS SWITCH IS FOR EMERGENCY USE ONLY.**



## WARNING

Removing the plunger while in storage could result in corrosion to unit points. A tag may be attached to the lanyard cable. **DO NOT** use it as a parking brake.



## CAUTION

Removing the plunger with power to the brakes could result in damage to the brakes.



## NOTICE

The safety break-away switch will **NOT** operate unless connected to a power source equivalent to or greater than an automotive type 12-Volt, 12-amp hour wet-cell battery.

## Electrical System



The electrical system in the recreational vehicle is designed for using both 120-volt AC (alternating current) and 12-volt DC (direct current) capabilities. All installations and designs are built to comply with safety requirements of NFPA 119, National Electric Code and the Canadian Standard Association.

The round pin on the receptacle is important for this safety device to function correctly. **NEVER** cut off this pin. When using an appliance in the receptacle without provision, use an adapter with a pigtail to be attached to the receptacle box to complete the circuit.

### Changes and Modifications

Any changes, alterations, additions, and/or modifications need to be performed by qualified electrical technicians, using only approved components that meet safety and code requirements. This includes owners, dealers, etc. who desire to make changes. The manufacturer is **NOT** responsible for any changes, or alterations, made to the 120 AC system of the unit.



## CAUTION

**Any electrical installation that does NOT meet the criteria of the manufacturer's specifications will void the warranty on the electrical system.**

**50-amp service is a 240-volt hook-up. There is no appliance or other component requiring 240-volts in the unit. For more information, see the section "50 Amp."**

To receive power into the unit, a power of 30 amp or 50 amp rating is required, depending on size and/or floor plan, and the number of appliances.

## DO NOT ATTACH TO A 240-VOLT RECEPTACLE.

Energy will enter through the main breaker and is distributed through the circuit breakers to the wall receptacles and appliances. The power cord will be approximately 26 to 45 feet in length. Each cord has the correct gauge of wire to carry the required voltage to the unit.

In some hook-ups, the power cord may not be long enough, and extension cords are required. Always use a cord with the gauge of wire equal to or greater than the power cord. Should you use a cord with a smaller wire gauge, overheating, loss of amperage and possible melting could occur.



## WARNING

**Never use a "Cheater" plug or extension cord which breaks the continuity of the ground circuit to the grounding pin.**

**Do NOT leave any unused portion of an extension cord in a "coil" as it may overheat, short-circuit wires and potentially destroy your extension cord.**

**Keep extension cords short.**

**Do NOT replace breakers or fuses with any rated at a higher amperage. Over fusing may cause a fire by overheating the wire.**

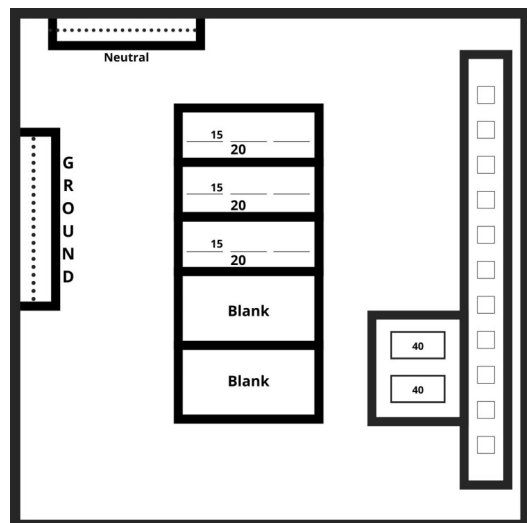

## 30-Amp Circuit Breaker in Load Center with Converter

On a 30-amp system, a maximum of 5, 120-volt AC distribution circuits are permitted. All breakers are sized accordingly to the power needs on each line.

The following generic drawing shows the circuit breaker alignment with number 1 being the main breaker on all floor plans. Depending on the size, floor plan, and options of the unit, circuits 3 through 6 will vary and possibly not all circuits will be used. Number 1 is 30 amp for the main breaker. Number 2 is generally the 20 amp air conditioner circuit. An owner must realize and understand that a unit has a total of 30 amp service available to be used. Conserving and choosing which appliance has priority in consumption needs to be part of the planning.



### Components:

**Roof Air Conditioners (Each): 15 Amp Each**

**Electric Water Heater: 12 Amp**

**Microwaves: 12 Amp**

**Hairdryer: 8 Amp**

**TV/DVD: 4 Amp/5 Amp**

**Chargers: 14 Amp**

**Refrigerator: 3.5 Amp**

Don't forget loose items such as toasters, electric skillets, and coffee pots also consume power. Make sure to include these in your planning as well.

## 50-Amp (optional on larger units)



On some larger units, with more appliances installed, it requires more 120-volt AC power to operate. Availability of 50 amp service is the best method of providing the owner with an increase of incoming power. 50 amp service is required for units with a second air conditioner.

Distribution of 120-volt AC power is accomplished in this manner. No.1 on the top of the center breaker, is 50-amp incoming current to supply your unit. Secondly, the No.2 or beside the main breaker will power your air conditioner. The remaining 6 to 12 breakers will supply power to appliances as marked on the attached label. The quantity of breakers depends on the floor plan, options, and size of the unit. It is recommended against using any reducer adaptor when 50 amp service is not available. When using such an adaptor, you have reduced incoming power and cannot power all your appliances. Should you attempt to draw more power than the adaptor can handle, it will overheat, melt, and cause a fire hazard.

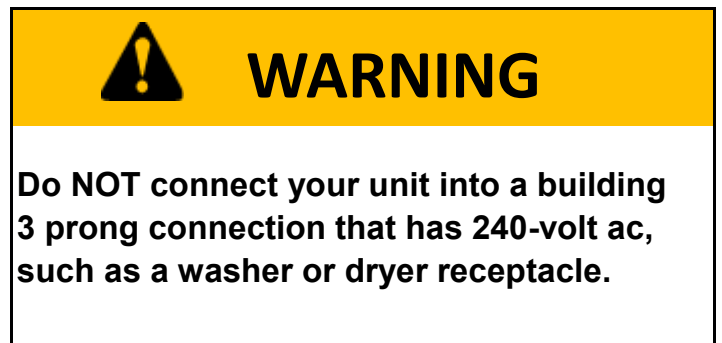

## Ground Fault Circuit Interrupter (GFCI) Protection



Each unit has a GFCI protection receptacle installed into the circuitry. In the event of a ground fault, a GFCI will trip and quickly stop the flow of electricity to prevent serious injury. Ground fault causes are from reverse polarity, faulty insulation, using a 2-wire extension cord, moisture, and earth ground.

Sometimes you may find the GFCI in the circuit breaker in the distribution box. Instead of following its normal safe path, electricity passes through a person's body to reach the ground. For example, a defective appliance can cause a ground fault.

This GFCI receptacle will **NOT** protect against short-circuits or overloads. The circuit breaker or the fuse in the electrical panel which supplies power to the circuit provides this protection. Incoming polarity is extremely important. You should be certain that the polarity of the external power is not reversed, in order to avoid harm to appliances and personal electrical shock. Polarity testers may be purchased in most electrical and hardware stores with the GFCI tester built-in.

During the use of the recreational vehicle, it is suggested to test the GFCI receptacle once per month. To test, press the "TEST" button in. The "Reset" button should pop out. Power should now be turned off at this receptacle and any receptacles down the line. To restore power, push, and then release the "RESET" button.

### 12-VOLT DC System

Most interior lights and appliances receive 12-Volt DC power through a converter output and/or the auxiliary battery. Exterior lights and brakes also use 12-Volt DC power from the tow vehicle battery and/or auxiliary battery through the seven-way connector and wire attached to the tow vehicle. All external wire connectors, such as the 7-way pigtail must be protected, kept dry and tight, to prevent any corrosion.



### Converter/Load Center

The heart of your 12-volt DC system is enclosed inside of the load center, including a 12V fuse panel, 120V breaker panel, and the converter unless you have 50 amp service and a free-standing converter. The fuse panel has 6 or more 12-volt DC fuse positions, depending on the output size of the converter. These fuses are mostly 15 amp in size. The 30 amp 12-Volt breaker is for a slide out if so installed. A fuse is also in the load center for protection should a battery be installed backward. All converters have a solid state of electronic components internally to produce clean 12V DC power. This load center will have a plastic front panel with a small door to access fuses and breakers. The function of a converter is to take 120-volt AC power and transform this energy into 12-volt DC clean power.

**The converter then performs as follows through the fuse panel:**

1. Supplies power to the lights in the unit.
2. Supplies power to all appliances as required for operation.
3. Provides charging voltage for an optional battery, if so installed.

**No manual switches are needed for this operation.**

Each converter has a built-in fan which operates through a load sensor control or temperature sensor. As more current is drawn, the fan will speed up, run faster or slow down, based on amp draw and/or temperature. Should the fan not run at all, the converter may have overheated and will cut-out and/or stop.

**NOTE: Converters with Lithium option is offered.**



## Battery Disconnect Switch

The battery disconnect switch, as shown, has one function, to cut-off or supply 12-volt DC power from the battery to the 12-volt DC distribution system. Insert the attached red plastic key in the “off” position and turn 90° to the “on” position. 12-volt DC power now moves from the battery, through the converter to the unit. When you wish to charge the battery by a power converter, the switch must be in the “on” position providing you have 120-volt AC power available.

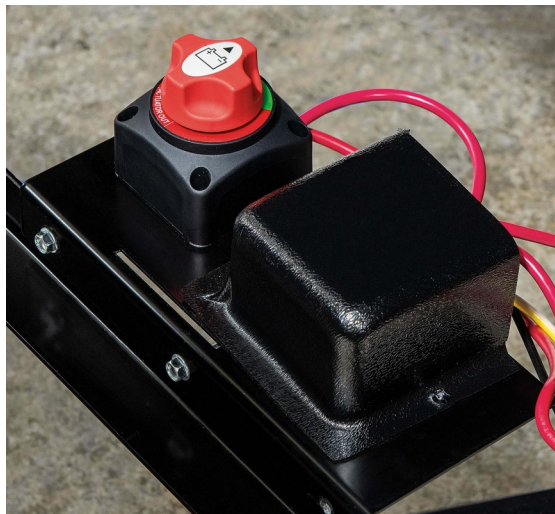



## Auxiliary Battery

All travel trailers and fifth wheels are pre-built to accept a battery. Batteries are **NOT** standard equipment on units. Some Fifth Wheels can be optioned with lithium batteries.

Recommended batteries are deep-cycle, as you may need longer, slow consuming power rather than cold cranking power. A battery is always required for a breakaway switch to function. A battery requires routine maintenance for a longer life. First, terminals need to be kept clean to avoid corrosion. Second, a battery is used daily and will consume water if the converter is in operation unless it is a sealed battery. Be sure to check the battery no less than every 30 days and keep the battery filled with distilled water. When the water gets lower than the top of the plates, the battery could suffer permanent damage. Most good deep cycle batteries are not maintenance free.

A converter will **NOT** overcharge a battery unless a battery has a dead cell, or the converter has a malfunction. Some types of converters have full battery charge shut-off. Other types reduce the rate of charge as battery conditions reach 12.7 volts DC or 1.265 specific gravity at 80°F. By electronic standards, a battery is discharged at 10.5 volts. Dropping voltage lower than 10.5 volts will begin damaging plates in the battery.

The interior lights receive power from the converter and/or auxiliary battery. The slide out switches are on the monitor panel. Small units, may have a separate slide-out switch. The bathroom and rear storage area will have their individual switches.

## 12 Volt DC-Circuit Breakers and Fuses

Circuit Breakers



This item has been installed in the unit to protect circuitry and components. Fuses are placed into the fuse panel with the converter or into a separate panel near the converter with access inside of the unit. Fuses are placed in your electrical system to protect wiring and components when overloads or short circuits occur. Radios, stereos, detector devices, and other components may have in-line fuses attached to their own wire harness. Fuses are placed in the converter for protection, should a battery be installed backward. The fuses will blow instead of the converter.

Circuit breakers are placed in several locations. An automatic reset breaker is placed within 18 inches of the auxiliary battery. The breaker will automatically reset upon cool down. A 30-amp automatic reset breaker is installed in the load center to operate the slide outs.

Other small breakers in the fuse panel operate the slide outs as well. AMP rating on these is 30, 20, and 15 amp. The colors of the breakers will vary.

Automatic reset breakers will reset by themselves when tripped. The warmer a breaker is, the longer it will take to reset.

All wiring used in the unit meets the correct amp rating correlated with the fuse and breaker in the respective panels as required by code.



The RV battery is placed in a parallel circuit with the battery on your tow vehicle, which is **NOT** supplied by the manufacturer. Care needs to be exercised to ensure not to drain both batteries together. There are two methods of avoiding this action:

1. Disconnect the tow vehicle when parked and/or using the unit.
2. A battery isolator may be installed in the tow vehicle to prevent a power drain from batteries in both vehicles. The device isolator has two useful purposes. It can send current from the alternator to both batteries simultaneously. The isolator also prevents draw from the recreational vehicle through the battery of the tow vehicle, preserving power to start the engine.

Contact your dealer should you desire to purchase an isolator for your protection. Two types of isolators are available: mechanical type and solid-state.



### Exterior Lights and Connector, 12-Volt DC

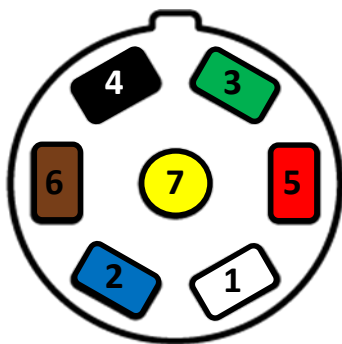

1. White, 10 gauge - Ground
2. Blue, 12 gauge - Brake
3. Green, 14 gauge – Clearance Lights
4. Black Positive, 10 gauge – Charge Line
5. Red, 14 gauge – Left Turn
6. Brown, 14 gauge – Right Turn
7. Yellow, 14 gauge – Back-Up

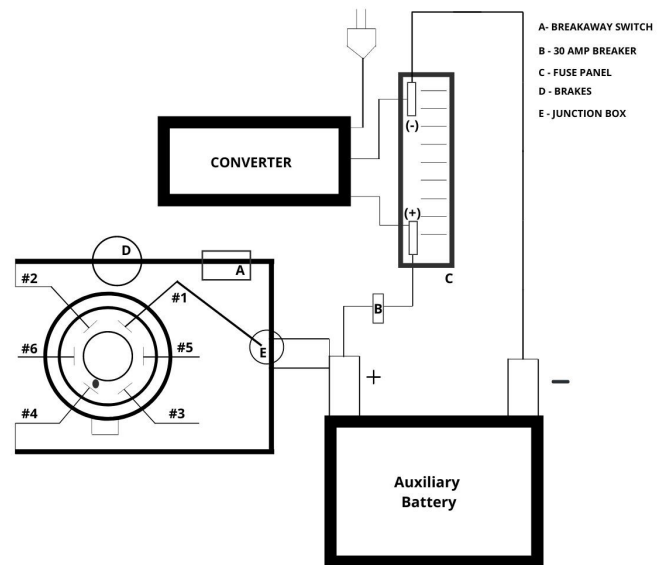

Power for exterior lights, such as taillights, turn, clearance, and brake lights, are supplied by the tow vehicle.

**NOTE:** the diagram above, is showing the color code and numbers from the 7-way connector and how power is fed to the exterior lights. The positive black wire is attached to the battery to transfer power to the unit. The connector between the recreational vehicle and the tow vehicle may build up corrosion due to moisture. You may need to clean these terminals occasionally to ensure good electrical contact.



## Porch Lights

Porch lights are placed on sidewalls, the left, and right sides. Switches for these lights, depending on the model, will be on the interior right or left sidewall. Occasionally, the switch will be on the light itself.

## Brake wiring

Both 10 and 12 inch electric brakes operate on 12-volt power supplied from the tow vehicle, which is transferred through the blue-positive and white-negative in the 7-way harness. There are no fuses or breakers installed in the brake wiring.

## Safety and General Information

All external wire connectors, such as the 7-way pigtail must be protected, kept dry, and tight to prevent corrosion. Loose electrical connections that are loose in any form can cause high heat and a potential fire. Use moisture resistant lubricants on exposed connectors such as the 7-way pigtail and the trailer end connector on the tow vehicle.

## Inverter



On some models, there will be an inverter as part of the power supply and one or two 12-volt DC batteries to provide power during travel. An inverter will be included with the energy supply. It is very important to **NOT** hook-up the battery backward. There are no fuses or other safeties installed as protectors for the inverter.

## Portable Solar Receptacle Panel (Optional)



A portable solar receptacle panel is installed on the wall of the unit. Solar panels are available through aftermarket dealers only. The main function is keeping any auxiliary battery charged while camping.

## Solar Panel on the Roof

A solar panel on the roof is available on certain model units. All units have a solar prep. When a full solar panel is installed by the factory, there will be either a 10 or 20 amp fuse included to serve as protection and supply power to the panel.

## Back Up Camera



A special bracket has been installed on the rear of the unit, just below the clearance light to mount a backup camera. The bracket has black and red wires to be connected to a 12-volt DC power supply from the unit's system to activate the camera. The camera is **NOT** included but may be purchased from your dealer. The system is intended for backup use only.



## Electrical Components

All power slide systems operate on 12-volt DC power provided by a converter or by a 12-volt distribution load center with automatic 20 or 30-amp breakers. For the best performance, have 120-volt AC power attached to your unit, feeding the distribution load center. The tow vehicle 12-volt power may also be used as required.

**To supplement the battery, use either one of these two choices:**

- A. Hook up 120-volt power to the recreational vehicle for converter operation.
- B. Use 12-volt power through the tow vehicle to the recreational vehicle battery.

Either of these methods will help ensure maximum electrical power for the slide-out motor, as well as, maintain the battery. The battery is an aftermarket item and is not supplied by the manufacturer.

## Operating Switch



Some models use a 2 or 3-position spring-loaded switch, hold "IN" to bring the slide out into travel position and "OUT" into occupancy position. On other models the slide-out switches are on the monitor panel. Press on the desired position and hold until the room is seated, and the gasket is slightly compressed. Do **NOT** force the room to move beyond sealing as damage could occur. It takes about 20 seconds to move the slide in or out. Do **NOT** attempt to operate more than one slide at a time. AMP draw per slide ranges from 12 to 18 amps to move slide-out "IN" on flush floor slide. Moving both could kick the breaker off.

## Monitor Panel Battery Condition:

When pushing the battery button, the highest light coming on indicates the battery condition. C-charging at 12.7 volts; G-good at 11.9 volts; F-fair at 11.2 volts; L-low at 6 volts. Press only one button at a time as one set of lights serves all functions.





### WARNING

**Stand clear of the room's interior path and verify the room's exterior path is clear before extending or retracting the room.**



### CAUTION

**When opening the slide room, DO NOT over-extend. The fascia board can be damaged. Because operating the slide out draws up to 30-amp current from the battery, some source of supplemental charging should be operating while extending or retracting the slide out.**



## Detectors

### What is Carbon Monoxide?

Carbon Monoxide (CO) is a highly poisonous gas that is released when fuels are burned. It is invisible and has no smell making it hard to detect with human senses. Under normal conditions, in a room where fuel burning appliances are well maintained and correctly ventilated, the amount of carbon monoxide released into the room by appliances is not dangerous. These fuels include wood, coal, charcoal, oil, natural gases, gasoline, kerosene, and propane. Such gases can build up in the blood, interfering with the body's ability to supply oxygen to itself.

CO is colorless, odorless, tasteless, and a highly poisonous gas. CO is 200 times more likely to replace oxygen in the blood. CO can endanger lives, even at low levels of concentration. Being aware of preventive action can save you and your family.

### General Detector Information

Due to the fact that a unit has a more confined space than a house, safety detectors will be activated much sooner, being that there is less air and oxygen in your RV. Each of these detectors has its own manual and instructions, providing additional information for its care and operation. The lifetime of each detector is up to 10 years and will need to be replaced as per the manufacturer's instructions.

The lifetime of each smoke detector ranges from 5 to 10 years and will need to be replaced as per the manufacturer's instructions.

**TEST ALL SAFETY ALARMS OPERATIONS AFTER THE RV HAS BEEN IN STORAGE, BEFORE EACH TRIP, AND AT LEAST ONCE PER WEEK DURING USE.**

### Combo Propane and Carbon Monoxide

Any recreational vehicle which contains a propane fuel system with propane consuming appliances requires a propane leak detection device for safety protection. Currently, this detector also serves as a carbon monoxide detector, as a combination protection device. A converter or auxiliary battery is required to supply 12-volt DC energy to operate the detector. There is no master cut-off switch or in-line fuse to disengage the detector, only a 15-amp fuse in the fuse panel or the red RV battery disconnect.

The CO/Propane Gas Alarm is an alarm that combines into a single, compact system with a powerful alarm that detects both Carbon Monoxide (CO) and Propane (LPG). The 35 series uses the latest microprocessor technology combined with two electronic self-cleaning sensors that operate independently off of each other. The combined unit can detect CO and explosive gases simultaneously.



### Operating Instructions

When the unit is first powered up, the CO sensor requires a 10 minute initial warm-up period to clean the sensor element and achieve stabilization. The green LED indicator will flash on and off during the 10-minute warm-up period. The unit cannot go into a CO alarm during the warm-up period. To test the unit during the warm-up period, press the test button. After the warm-up period is complete, the green power "on" indicator should glow continuously. If the "on" indicator light does not light see the section, Trouble-Shooting-Guide, in the manual provided by the manufacturer for further information.



## Gas Alarm

When powering the gas alarm, it will have a warm-up period of approximately 1 minute. After 1 minute, the alarm can detect explosive gases and will energize the relay.

## Simultaneous Carbon Monoxide (CO) and Gas Alarms

The risk of propane gas explosions is serious. Your alarm unit gives the gas alarm a higher priority during simultaneous alarm conditions. If the unit generates alarms for both gas and CO at the same time, the gas LED will flash red and the beeper will sound. The CO LED light will be a solid red until the CO is ventilated out of the RV, at that time the LED light will return to the green operational/safe color.

## Carbon Monoxide (CO) Alarm

The red CO LED light will flash, and the alarm will sound 4 “beeps” then be silent for 5 seconds. These signals indicate that the CO level is over 35 ppm. **IMMEDIATE ACTION IS REQUIRED.** Review the procedures necessary to take when an alarm goes off. You can find this procedure in the supplied user manual. This cycle will continue until the TEST/MUTE button on the front of the alarm is pressed. Ventilate the RV. The red light will stay on until the CO has cleared, or the alarm will reactivate in approximately 6 minutes if the CO is still present. **DO NOT RE-ENTER THE RV!** This alarm will return to normal operation after the RV is properly ventilated.

## Propane Gas Alarm

The red LED light will flash, and the alarm will sound a steady tone whenever a dangerous level of propane is detected. **IMMEDIATE ACTION IS REQUIRED!** See the procedure that needs to be taken during a gas alarm. The detector will continue to alarm until the TEST/MUTE button on the front of the alarm is pressed. Ventilate the RV. The red LED light will continue to flash until the propane has cleared, or the propane alarm will reactivate in approximately 5 minutes if the gas is still present. **DO NOT RE-ENTER THE RV.** This alarm will return to normal operation after the RV is properly ventilated.

## Malfunction/Service Signal

If any malfunction is detected, the gas LED light will remain off and the operational/CO LED light will alternate red/green and the alarm will sound once every 15 seconds. Press the TEST/MUTE button. If the TEST/MUTE button does not clear the signals, check the battery voltage. If the battery voltage is not low and the unit will not return to normal operation, immediately remove the alarm and return for service or warranty replacement. See the warranty section in this manual.

## Operation Audible Signal Visual Signal

NORMAL	NONE	STEADY GREEN
CO ALARM	4 “BEEPS” EVERY 5 SECONDS	STEADY RED
PROPANE ALARM	CONSTANT	FLASHING RED
ALARM MALFUNCTION	“BEEP” EVERY 30 SECONDS	ALTERNATING RED/GREEN
END OF LIFE	“BEEP” 30 SECONDS	RED/RED GREEN/GREEN FLASHING



### Brownout Protection

The unit can tolerate a short power interruption and brownouts where the circuit voltage drops as low as 1 VDC. If the brownout lasts too long, the unit will reset and operate as described.

### Low Power Operating Instructions

This alarm will operate normally down to 7 VDC. Do **NOT** operate this alarm below 7 VDC. This alarm is designed to detect CO and Propane but is **NOT** designed to detect smoke.

### End of Life Signal—5 Years' Service Life

All 35 and 25 series models include an (EOL) signal indicating the sensor has reached the end of its service life and you **MUST** replace the alarm. The signal is the LED flashing red/red/green/green with a beep every 25-30 seconds. The EOL signal may be reset by pushing the TEST/RESET button on the alarm. This will reset for a period of 72 hours or 3 days for a total of up to 30 days. After 30 days, the signal cannot be reset, and that alarm **MUST** be replaced. **DO NOT DISCONNECT THE ALARM UNTIL YOU HAVE A REPLACEMENT ALARM AVAILABLE TO INSTALL!**

### Fire Extinguishers

A fire extinguisher is installed in each unit and is located near the entrance door of the RV. Be familiar with its location and operating instructions as printed on the extinguisher. Inspect the extinguisher at least 2 times per year or more often, as instructed on the extinguisher. The extinguisher is rated at 1-A:10:BC as required for recreational vehicles.



## Smoke Alarm

Due to having an open flame while cooking with propane, it is required to have a smoke alarm placed on the ceiling between the bedroom and the kitchen. Power to operate this alarm is supplied by a 9-volt battery inside of the alarm. The battery must be tested each week to make sure it is operating correctly.



## WARNING

**Test smoke alarm operation after vehicle has been in storage, before each trip, and at least one per week during use. Failure to do so may result in death or serious injury.**

## Operating Instructions

The smoke alarm is in operation once the battery is correctly connected and the protective lock is removed. The LED light will flash every minute to show the battery is supplying power to the alarm. When production of combustion is sensed, the unit sounds a loud alarm which continues until the air is cleared. Each smoke alarm has its own manual and is normally found in your supplied materials with the unit.



## Testing

Test the alarm by pushing the test button on the smoke alarm cover for at least 3 seconds, until the alarm sounds. The alarm sounds if all electronic circuitry, horn, and battery are working. If no alarm sounds, the unit has a defective battery or other failure and must be replaced immediately. The lifetime of an alarm is 10 years maximum.

Test the smoke alarms after the recreational vehicle has been in storage, before each trip, and at least once a week during use.

Stand at arm's length from the smoke alarm when testing. The alarm horn is loud to alert you to an emergency. The alarm horn may be harmful to your hearing. The test button accurately tests all functions. Never use an open flame from a match or lighter to test this smoke alarm. You may ignite and set fire to the smoke alarm and your RV. The smoke alarm will **NOT** sound in and around flames, only smoke.





# Technology

## Level Mate Pro

Level Mate Pro is a device that indicates the level status of your unit. It can be used with an Android or an iPhone via Bluetooth technology. There is an owner’s manual included with the Level Mate Pro that includes how to set up, install, etc. Refer to the owner’s manual for further instructions. You must download the app for use. This is exclusive to specific models of RV’s.

## USB Charger

The USB charger is a recent addition to units and is installed in many products, some optional, others standard. It operates on 12-volt power DC to charge cellphones and other small items. Hook-up is: Red is positive and black is negative.

## TV Antenna – Stationary

The TV antenna has a rigid base to mount the receiver head which cannot be rotated or raised up. Inside the unit, on the wall, is a power supply with a brown cover where you hook up to TV and Satellite. There is an on/off button on the power supply to engage the booster, located inside of the antenna head. This antenna also serves as a radio receiver for the sound system in the unit. The location of this power supply is on the wall, above the space for the TV, freestanding or wall mounted. It could also be behind the TV or potentially on the ceiling, close to the TV location.

## Entertainment Components and TVs

All radio’s, TV’s, CD, and DVD players are purchased and come with their own operating manuals. Some are on CD while others are paper manuals. Read them carefully and completely before operating your equipment.

## Monitor Panel

Smaller red switches, 5 to 8 in quantity, operate appliances, lights, slide-outs, awnings, and possibly a generator and fuel tanks. Follow directions as given on the panel board as to what each switch will operate.



## Electronics Panel:

Control anything from heating to lighting through the Electronics panel.



## LCI OneControl Panel:

Two different sizes of panels may be used and mounted on the interior wall inside of the entrance door.

To turn the panel on, there is a push button switch at the center bottom of the board on the wall mounted panel. It is not identified as a switch. In the front baggage area, under the front floor, is a group of module boards.

To operate your system, there MUST be 12-volt DC power available. Without power, there will be no operation. Either a converter or battery will suffice. Current units will not have removable panels but will be attached to the inner wall. To have action, press the switch to turn the board on. After 5 to 10 seconds, it will light up with 1 to 4 or more items displayed.

Components covered and operate are awning, lighting, slides, and leveling, requiring 12-volt DC of power to function. Other items may be the furnace, water heater, water pump, leveling, and air conditioner.

When powering or waking UP the system, the MyRV application will run automatically as it is pre-configured to do. For the MyRV application to operate power must be provided. This will power various controllers located throughout the unit. Please note that with power to the unit, the tablet should always be able to gain access to the Control Panel. It may take several minutes for the tablet and hub to fully energize and communicate. Please allow this time for the system to establish communications.

For the leveling portion, find the 'ONE CONTROL' DECAL inside of a cabinet door in the same area. Follow the instructions on this decal to level the unit. Both models have the option of either a 4- or 6-point leveling system installed when new. Each system will have an instruction sheet installed on the inside of the right front baggage door.



## iRV System:

iRV is a system installed in various VENTURE models and can help make camping in your RV a breeze. This panel can be operated through the panel mounted on your units wall, or through the iRV app and Bluetooth. Control your slides, awnings, lighting, and even check tank levels using this technology! You can find more information regarding this system through your local dealer or by referring to our YouTube page!



# Slides

## Slide-Out Systems

VENTURE RV builds units on frames supplied by several manufacturers using different slide systems and components. All slide-outs require some form of 12-volt DC power, supplied by the dealer installed battery and/or converter requiring 120-volt AC power.

Following are descriptions of several types of slides with electric components.

### Slide-out Rooms

Having various models of trailers, we use numerous slide-out systems. Several different vendors supply components, loose and/or attached to frames.

Before operating the power slide-out system, read and become familiar with these instructions, along with the components and operation methods. Most of these components are inside of the enclosed underbelly cover and cannot be seen.

#### Monitor Panel Slide out Operation:

Two different panels are used in production. Large panels operate slides and the power awning or have a blank cover. Always be sure the slide fits tight, in or out, to protect against temperature and rain.

### Main Floor Slides Below Floor Slide System (BFS) (Flush Floor or Standard)

First is an under-the-floor slide-out mechanism with a notched track welded to a cross member, matching with a cog gear attached to the drive shaft, "LCI" (Lippert Components). As the motor turns, a ram moves the gear on the track. Mechanisms operate the same on all main floor concepts.

### Above Floor Slide-Out

The base is attached to the floor and sidewall. As the motor runs, it moves the slide in or out. On large slides with 2 tracks, a cross shaft will connect both tracks, operated by one motor. Access to all these components is inside the unit.

## Bedroom Slide

Two styles of bedroom slides are Schwintek and low-profile floor mounted slides. Low profile assembly is placed and attached to the floor of the front bedroom slide, closet, and wardrobe slides. Two nylon blocks and metal brackets are attached to the side wall opening point to ease slide out movement, in or out. This includes all hardware, motor gears, shafts, track, and framework combined into a single unit.

### Schwintek Wall Slide

The Schwintek system is composed of four tracks placed on the outer sidewall of the slide, at the bottom and near the roof line. On each side, an extrusion is attached to the sidewall with a motor inside at the top. A gear is mounted to the motor that will run on the upper track to move the slide in or out. There is a wire harness along the side of the extrusion.

Power from the 12-volt DC source applied through a module board allows for the operation of the slide.

It is important to keep the tracks clean from dirt and debris. Additional information can be found in the supplier's manual about manual operation, error codes, and any other issues.

Operation error codes are listed and found in the manual supplied by the manufacturer of the equipment, for the circuit board, and other components.



## WARNING

**Always make sure the trailer is level before operating the slide out room. Always make sure the room path is clear of people and objects before operating. Always keep away from slide rails under the unit when the room is in motion. Failure to follow these instructions could result in death or serious injury.**



## Manual Override Access Locations

An above floor system has a 12-volt DC motor located under the sofa or dinette. Should 12-volt power fail and there is no 120-volt AC power available, follow the listed directions.

### Manual Override (Flush Floor or Standard)

On the rack and pinion frames, there is a 1/2" shaft coming through the main rail of the frame. A 3/4—inch nut is welded to the shaft. Use a socket, extension, and ratchet to move the slide. You will find this nut on the opposite side of the frame that the slide is on. On some units, the stabilizer jack crank handle will also work on the shaft with the attached 3/4" nut.

### Manual Override (Bedroom Slide)

Access to move the slide when no power is available under the bed:

1. Lift the bed plywood and mattress up.
2. Remove all cargo stored inside.
3. Pull up the plywood panel covering the mechanism.
4. Use a crescent or 1" wrench to turn the tube at the foot end of the bed.

### Manual Override (Schwintek System)

#### A. Electric Manual Override

1. Locate the circuit board.
2. Press the "mode button 6 times quickly, press a 7th time and hold for approximately 5 seconds. The red and green LED lights will begin to flash. This confirms the override mode.
3. Release the mode button.
4. Back inside the unit, use the normal control switch to retract the room.

## B. Manually Push the Room in or out

1. Unplug both motors from the circuit board. This will release the motor breaks.
2. Push or pull the slide out room as desired. Larger rooms may require several people to push. Keep both sides relatively even.
3. When the room is completely in, plug both motors back into the circuit board to apply the brake for road travel.
4. The room must be travel locked during travel.

**Don't forget, each slide has its own motor. If the slide moves at an angle, one motor may be disconnected or failed to move.**

### Manual Override For above Floor Slide out (Single or Double Rams)

Access to the ram is under the floor slide, sofa or dinette, and is from the front. Lippert Components has a similar motor, but less draw and it requires a 5/8" socket, ratchet, and extension shaft.



# Tanks

## Systems

Your recreational vehicle has a complete water system to carry fresh water, as well as holding tanks for used water. Each group has its own explanation along with its own operation.

### Tanks

All units produced have a fresh water supply tank installed. In most models, they are placed under the floor in the frame area, and protected with a cover and a steel frame carrier, to be used when city water is not available. A cover is provided to protect plumbing parts and is not a code requirement. On some larger units, a second optional tank may be installed. Each tank has its own drain spigot to remove water, when so desired, especially in wintertime. Each storage tank has an overflow line. **DO NOT** install a shut-off valve at the lower end of the line.



## WARNING

**Potable water only. Sanitize, flush, and drain before using. See instructions manual. Failure to comply could result in death or serious injury.**



## CAUTION

**DO NOT leave the tank unattended while filling, as an over filled tank will build pressure, causing the tank to crack, rupture, and leak or even damage supports holding it in place.**

### Monitor Panel Water Tank Condition:

Operation requires 12-volt DC power, supplied by the battery or converter. Sensors, 1 negative and 3 positives, attached to a resistor to feed information to the display panel. To operate, place a finger on the button and push. A light will illuminate indicating the water level of the tanks or the charge condition of the battery. "Galley" will light only when the floorplan includes the second gray water holding tank.

## 12-Volt Demand Pump

When water is desired and the RV is not hooked up to city water, the tank will be the supply. On the monitor panel is a switch to turn on the 12-volt demand pump. Power from the pump is supplied by the auxiliary battery or converter. The pump will self-prime when started, supply water, and continue to run until approximately 40 pounds of pressure is achieved. When pressure drops to 20 pounds, the pump will restart. Some cycling in the pump may occur. A check valve is built within the pump to prevent water from flowing into the supply tank. The pump has a small filter attached on the "in port" side to prevent any foreign object from entering the pump. You need to remove the lower cup and clean it out or replace the filter annually, or more often if used more. When the pump is not being used, turn the 12-volt power off at the switch, located on the Monitor Panel. Occasionally, your water pump may start/stop quickly (within a second). This is referred to as "cycling". The cause for this noise may be a slightly open faucet, water saver washer at the end of the faucet spout, or other restrictive issues. If the pump cycles every 10 to 15 minutes, there may be a slight water leak somewhere. Check the valve in the city water fill, plumbing fittings, or the pressure valve in the pump. On some units with water pumps and valves in the front storage area, a wood or metal cover has been installed.

### Fresh Water Lines

2 lines, generally red for hot and blue for cold, will move water to any faucet desired.

### Low Point Drains

Low point drains are placed on the recreational vehicle to drain water lines, tanks, and water heaters to prepare the unit for winterization and sanitizing systems.

Fresh water supply tanks will have their own separate drains under the floor and/or frame, with a valve for drainage and overflow.

Plumbing lines also have low-point drains located in various areas. You may find hot and cold water lines coming out of storage areas, out of outer skirt metal, and through the under belly covers. Water should always drain out to the ground, not into the underbelly cover.



# Fresh Water System

These tanks are not designed to hold pressure. Leaving a tank filling up unattended, may cause a tank to overflow, pressurize, break, leak, and bend the carrier frame, which is not a manufacturing defect. **DO NOT** install a shut-off valve at the lower end of the line.

## Components listed are:

**P- Pump, 12V, DC:** To supply the unit with water when city water isn't available.

**G- Gravity Water Fill:** To place water into the fresh water tank, remove the cap from the fill tank. Insert a hose into the 1-1/4-inch flex tube 4 to 6 inches.

**C- City Water Fill:** this is where you attach a garden hose from a known good water source to fill both supply tanks and water lines.

## T- Water Storage Tank

**F – Filter:** Remove the cap to clean or replace the filter.

**S – Siphon hose:** To draw liquid antifreeze or sanitize solution.

**Valves to operate**—Open and close to control water movement in the lines in the unit.

**V— 1:** Regulates Siphon hose. Must be closed except to draw antifreeze or sanitizing solution.

**V – 2:** Open only when the water pump is used to draw water from the supply tanks. Close the valve when the siphon hose is being used. The siphon hose is 4 to 6 feet long with a male connector on one end and nothing on the other end.

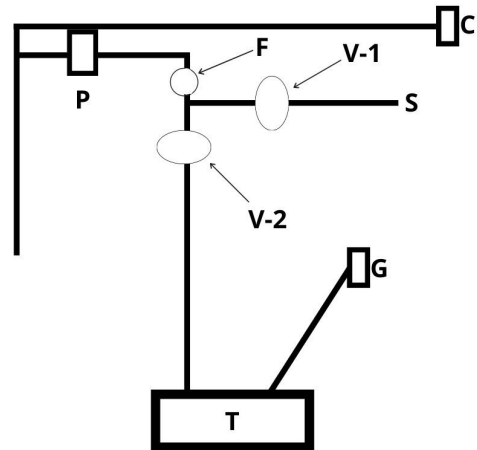

## Filling the Fresh Water System

### City Water Fill

To receive water into the system through a direct hook-up referred to as "City Water Fill", attach a hose to a good water source.

### Gravity Water Fill

To place water into the freshwater tank, remove the cap from the fill tank. Insert a hose into the 1 1/4" flex tube 4 to 6 inches, from a good water source. Each fresh water tank has an overflow line. The overflow line is attached to the gravity water fill tank. Water will come out of the screen when it is full. **DO NOT** overflow the tank as it could burst. During the tank filling process, view the monitor panel for the volume of tank fullness.

**NOTE:** Enter the unit, and open any faucet to allow air to escape, as there may be some air pockets. The water heater (if so equipped) will fill first. There are different fresh water entry's that are used depending on your RV's floorplan. All water containers have 3 exits; (1) draw water with the pump throughout the unit, (2) drain the spigot from the tank, (3) overflow line, which is smaller than a fill hose.



## Sanitation System

### Sanitizing and Filling the Potable Water System

Prepare a chlorine solution using  $\frac{1}{4}$  cup of bleach to one gallon of water. Prepare one gallon of this solution for each 15-gallon capacity of the tank. As designed and constructed, this method will sanitize the plumbing system.

**Example:** For a 45-gallon tank, put 3 gallons of solution into the tank.

#### To Sanitize:

1. Close all drains, tanks, and low-point drains, and have the by-pass closed to the water heater.
2. With the unit completely drained, open the V1 valve, close v2 valve, and insert the siphon hose into the container with sanitation solution. Start the pump to draw liquid into the system until liquid comes through the faucets. Close the faucets and the pump will shut off. The line are now full.
3. Should you desire to sanitize the tank, pour sanitation solution into the gravity water fill, which will drain into the fresh water tank.
4. Add additional water to the tank through the gravity water fill.
5. Open the faucets, close V-1, and the V-2 valve needs to be open. Start the pump to draw the liquid from the tank through the water system. When liquid flows freely from the faucets, close the faucets. The pump will shut off.
6. All this water solution to stand in the system for three hours.
7. Drain the solution and flush with fresh water.

To remove any excess chlorine taste or odor, prepare a solution of one-quart vinegar to five gallons of water and allow this solution to agitate in the tank for several days by vehicle motion. Whenever the demand pump is not being used, be sure to **TURN OFF** the 12-volt power to the pump.

## Drainage (Fresh Water)

All permanent freshwater tanks can be drained. The type of drain used is a turn valve with an open/close position.

The valves will be at the “lowest” point of the water lines. To drain the supply lines and the entire system, you need to follow the steps listed below.

#### To drain the system:

1. Open all faucets including exterior shower.
2. Open the fresh water tank drain.
3. Open the water heater drain and remove the anode rod.
4. Open all (2 to 4) low-point drains.
5. Open the toilet valve, hold or block, if needed.
6. To empty the pump, start and allow it to run up to 20 seconds.



## Draining the Tanks

A final part of the sanitation system is the drainage of the holding tanks. Realizing that the dump stations will vary, place the unit as level as possible to make drainage easier. Some tanks drain from the center, requiring the unit to be level or slightly higher upfront. Others drain from the end, permitting a slight tilting to the side which the drains are on.

Make sure the pump valves are closed before removing the cap and attach the adapter onto the valve housing. Turn the adapter 10° to lock onto the pegs. Attach a flexible sewer hose to the adapter and secure it with a clamp. Place the other end into the approved sewer system.

You may now open the 3" drain valve to drain the sewage tank first. Open the valve on the grey water tank last to utilize contents, to wash and rinse the hose, and drain the lines.

Most states and parks have strict laws and regulations to prohibit dumping wastes of any kind into anything other than proper disposal facilities or sewer systems. Almost all privately-owned parks have either a central dump facility or offer a campsite hook-up for sewage. You can find lists of many dump facilities throughout the United States in Woodall's, Rand McNally Camp Guide, Good Sam Camp Guide, KOA Campgrounds Camp Guide, or other various publications. Some fuel stations may also have dump stations.

## Maintenance for Holding Tanks

The following maintenance is recommended by our holding tank suppliers to keep the tanks clean and to keep the probes, supplying information to the monitor panel, free of debris and build-up.

### Gray Water Tank (Waste Water):

Fill the tank with 5-10 gallons of warm water. Add a degreaser such as a citrus cleaner or Dawn dish soap. Leave the solution in the tank while traveling. Rinse and drain the tank.

### Black (Sewer) Tank:

Fill the tank with 3 to 8 gallons of water. Add one bottle of drain cleaner, such as Drano or Liquid Plumber. Leave the solution in the tank while traveling. Rinse and drain the tank.

## Heated Holding Tanks

As the manufacturer, we use only heat from the furnace through the heat ducts in current production. Either 2" tubing from the furnace to the heat ducts or holes are drilled directly into the floor duct into the tank compartment. **(Not available on all models.)**

## Bypass Kit

**Valves** – Handles in the horizontal position allow water to flow into and through the water heater and from the water heater upon demand. The valve on the bottom and top portion of the bypass kit are choice directional flow valves, not shutoff valves.

When the bottom valve is in a vertical position it will prevent water from flowing into the water heater. The valve on top of the bypass kit, when in a vertical position, will not allow back flow into the water heater. Now you can send anti-freeze liquid through the unit plumbing system without filling the water heater.

**There are several reasons for not placing anti-freeze into the water heater:**

1. Costly – It would take an extra 6 to 10 gallons of antifreeze.
2. Anti-freeze can be very corrosive to the anode rod causing premature failure.
3. It can leave sediment in the tank.



## WARNING

**DO NOT use ethylene glycol (automotive antifreeze) or methanol (windshield washer antifreeze) in your fresh water system because they are harmful and fatal if swallowed!**





## Black Tank Flush System

The flush system is designed and built to rinse the waste holding tank after the tank has been drained and dumped completely of water and solids.

1. Attach a fresh water source to the tank flush connection. Be sure the termination valves are open on the holding tanks.
2. Turn on the water, allowing it to rinse through the tanks.
3. Rinse for several minutes to remove any foreign matter from the tank.
4. Remember the moisture content may give you false readings on your monitor panel indicating it is full. Allow time to dry out the tank or recharge for the next usage.



## CAUTION

**DO NOT use the tank flush unless the tank is empty and the valve is open. This can cause unsanitary conditions, illness, or personal injury.**

## Faucets

The basic operation of a faucet is the same as in a home. Open the knobs for the water supply. Close the knobs when enough water volume is achieved. It is normal to experience occasional air pockets in the system.

## Bath and Shower

Your bathtub and shower are built with an ABS or fiberglass material, like those in a home. Shower curtains or doors are provided with the unit and must be used to prevent water from spilling onto the floor, possibly causing damage. The showerhead used in the bathroom has a non-positive shutoff valve and will drip slightly in the shut-off position. A vacuum breaker is also built into the faucet to permit water in the hose to drain out as a code requirement. Before beginning a shower, be sure the water heater is lit. Adjust the faucet for the desired temperature before entering the tub or shower. When the shower is completed, be sure to turn the water off at the faucet. Used water will drain through the plumbing pipes into the gray water holding tank. Remember the capacities of the water heater and the gray water holding tank. Longer showers in RV's are not suggested due to the limited amount of water that is available. To conserve water, minimize shower length.

## Toilets

### Foot Flush

Prior to using the toilet, add a proper amount of deodorant chemical into the toilet water. Flush the contents into the tank plus 2 to 3 gallons of water. Push downward further to flush contents into the waste tank. Release the pedal slowly to close the flush operation.

### Operation

Unlike the toilet in a house which uses 4 to 7 gallons of water per flush, a recreational vehicle uses 2 to 3 quarts to save water and space. When insufficient water is used during flushing, waste materials may not evacuate properly from the drain lines to the tank, causing "clogging" in the pipe.

When hooked up to a sewer drain at a campground, always keep the termination valve **CLOSED** until the tank is at least  $\frac{3}{4}$  full. This will provide enough water to assist in the complete draining of the tank. Your dealer offers a complete line of deodorants, chemicals, and other convenience products for use and can assist you with these needs as they may already have them in stock.

### Using the toilet and tank system

When camping, you should always have 4 to 6 inches of water in the toilet bowl. The toilet system performs better when you run water 10 to 20 seconds after flushing to ensure wastes will proceed to the bottom of the tank.



## Vents

A very important part of your sanitation system is the vent system in your unit. These vents release air from holding tanks allowing water to enter. Vent pipes are attached to the holding tank, go through the walls, and cabinets to the roof, and vent outside. On some models, a portion of the vent pipe may be part of the drainage system referred to as a “wet vent” or side vented through the wall of your RV. As air flows upward, water will be draining downward.

An important part of the sanitation system is the holding tanks for waste materials and water. These are located below the floor of your unit.

### Gray Tank:

Waste Water from the bathtub, shower, and sinks will drain into this container. No special preparation is required, however, you may wish to add baking soda or a Thetford chemical to reduce odors from food particles in the system.

### Waste Tank:

The toilet drains into the waste or the “black” holding tank. (On some models, gray water may also drain into a black tank.)

For correct preparation follow the steps listed below

1. Release two quarts of water into the toilet bowl.
2. Place the recommended quantity of chemicals for the waste holding tank, as per instructions on the bottle, into the toilet bowl.
3. Flush liquids into the tank and allow up to two gallons of water to flow into the tank.

Each time you drain the tank, follow the instructions listed before using.

All drainpipes for the sink and shower will have a “P-trap” installed into each line. Water in these traps prevent odors from escaping into the unit. During travel, water from the p-traps may spill and permit odors into the unit. These odors come from fats and food particles decomposing in the tank. By adding water and using an RV approved deodorizing agent, contents will dissolve faster, keeping the drain lines and tanks clean and free-flowing. These chemicals are available at various RV supply stores.



## CAUTION

**It is important to use adequate water to flush the black tank, and have several gallons of water with chemicals in the tank. This helps the flow of waste and reduces solid waste build-up.**



## CAUTION

**Keep the drain valve closed to minimize the presence of sewer gases. Sewer gases can be present when the RV is connected to the campground sewage hookup. This can lead to illness or personal injury.**



## Propane Fuel System



The fuel system in the recreational vehicle has numerous components such as piping, copper tubing, brass connectors, hoses, regulators, and appliances.

Propane is the only fuel permitted to be used in a recreational vehicle and its appliances. An agent has been added for detection, should a leak occur, or a valve accidentally is left open. It is important for a recreational vehicle owner to recognize and identify the smell of propane vapor, for his or her safety.

Other fuels are available but cannot be used in an RV because:

1. No orifices are available for appliances for either butane or natural gas fuels.
2. Butane also cannot be used below freezing temperatures because the boiling point is 30° F.

Propane fuel is stored in liquid form under high pressure in special containers. The boiling point is -44°F, the temperature when vapor ceases to flow. Fuel will change to vapor when released from the container. Appliances are not designed to operate with liquid. The liquid will damage O-rings in the valves and leave a sticky, oily residue, causing poor or no operation in the regulator.

For every 10 degree increase in temperature, the pressure of propane in a container rises 1.5%. For example, if you fill the container in 0-degree weather, then fill in 80 degree weather, you now have a container filled at 92%, a potential problem with the 10% valve spewing out propane vapor.

## Overview of Typical LP Gas Hook Up

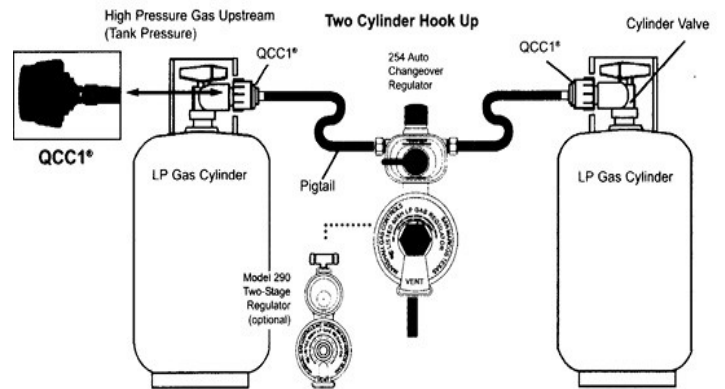

The propane cylinder is a D.O.T. approved container to hold liquid propane under high pressure, normally a 20 or 30 capacity.

The open/closing valve, referred to as an OPD cylinder valve, is always to be closed unless hooked up to a propane system or when filling the container. The valve assembly has 3 valves in one body.

1. The port used to fill the container and draw propane out is controlled by the upper 3-sided knob on top.
2. 10% valve, a small screw on the side of the main body allows any air to be released and indicated when a container is filled at 80%.
3. Incoming positive seal valve must be pushed inward with fill nozzle or by POL fitting to draw vapor out for appliance use. On the bottom/inside is the float which closes when 80% of capacity has been reached. This permits expansion space in the tank when the temperature rises.

At any point a container is disconnected, **BE SURE** to install the dust cap over valve entry (if so equipped.)

Whenever the container is detached from the propane system, **DO NOT** allow the cylinder to move or roll around while transporting to and from the propane supplier.



## CAUTION

**DO NOT** use tools to open or close the tank valve. Hand tighten only to avoid damage to the valve or handle.



## Servicing and Filling Propane Containers

Filling a propane container must be done carefully and correctly. Only a qualified person, properly trained on inspection, filling, and safety procedures should fill containers.

A new container must be “purged” before placing into service and must never be overfilled. Purging is an operation performed by your dealer or propane agency to remove any atmospheric air. As an owner, you **DO NOT** need to be concerned regarding this procedure, unless you permit the valve to be open when empty.

When refilling propane containers, they are generally removed from propane containers or tie downs. **BE SURE** to reinstall correctly, as you remove these components and test for leaks.

When propane containers are filled to 80% level, there is available space for safe expansion of the vaporized liquid. Should your container become slightly overfilled, pressure may rise due to the hot sun. It could cause the overflow valve to blow off and emit a small quantity of propane vapor. This can be detected by a strong odor around the tanks. Keep open flames away from this area. It is best to remove the bottle, take it to a safe area, and burn-off the excess.

When disconnecting propane containers, turn the ACME fitting in a clockwise direction because left-handed threads are utilized. When reconnecting, turn connections counter-clockwise. Connections must be tight, however, **DO NOT** over tighten.



## WARNING

**DO NOT place propane cylinders inside the vehicle. Propane cylinders are equipped with safety devices that relieve excessive pressure by discharging propane into the atmosphere. Propane is highly flammable. This can lead to a fire or explosion and result in death or serious injury. DO NOT fill propane container(s) to more than 80 percent of its volume as liquid propane. Overfilling propane container(s) can result in uncontrolled propane flow, which could lead to a fire or explosion and result in death or serious injury.**

## Installing Propane Containers

Recreational Vehicles are equipped with 20 and 30 pound propane containers, depending on the floorplan models and size of the unit.

**Mounting and attaching instructions are listed below:**

1. Thread the long rod into the base plate.
2. Set both bottles into the base.
3. Drop the double hook bracket over the rod and hook onto the bottles.
4. Attach the wingnut to hold the bracket and tighten to hold the bottles to the plate.
5. Attach the regulator with the vent down to the bracket.
6. Attach the main hose from the regulator to the manifold fitting in the frame.
7. Attach the two short pigtail hoses to the regulator and bottles at the ACME fitting.
8. Test all propane connections for leakage.

**To remove the propane containers for refilling:**

1. Remove the bottle covers (if used).
2. Close the main valve on the container.
3. Remove the two hoses at the ACME connection.
4. Install the rubber cap over the valve – ACME connection (if so equipped).
5. Remove/loosen the wingnut holding the clamp hook.
6. Remove the clamp hook.
7. Fill the bottle and reverse the procedure to install. Test all connections for leakage.



## Regulator



Propane regulators must always be installed with the regulator vent facing downward. Regulators that are not in compartments have been equipped with a protective cover and that cover is kept in place to minimize vent blockage. Should a vent be covered or blocked, the regulator cannot function or operate. The regulator has the only moving components in the propane system. The sole function is to reduce the high and varied pressure from the propane containers to a safe and consistent low operating pressure.

If the pressure is too high, it affects performance and safety. Should pressure be too low, appliances will **NOT** operate correctly. An authorized technician with the proper equipment should perform such tests and adjustments, as may be required.

The propane regulator used on Classics and Escapes is the standard two stage regulators. This standard regulator is used on smaller units.

After filling the cylinder, connect the pigtail hose and slowly open the bottle valve. **DO NOT** forget to check for leakage each time you refill the cylinder or disconnect any part of the propane system.

The second type is the automatic two stage regulator used on larger units. With both cylinders full of propane, turn the lever on the regulator towards the cylinder you wish to use first. This will now be the supply cylinder and the other is a reserve. Slowly open both cylinder valves.

The indicator on top of the regulator will turn bright green. When the cylinder becomes empty the indicator will change to bright red or orange. Now turn the lever to the side of the full bottle and the green signal will return. You may now remove the empty bottle to have it refilled without interrupting the flow from the full bottle. After filling the cylinder, connect the pigtail hose and slowly open the bottle valve. **DO NOT forget to check for leakage each time you refill your cylinder or disconnect any part of the propane system.**



## WARNING

Your vehicle has exterior combustion air inlets. Appliance pilot lights should be turned off during gasoline or propane refueling.

**(REQUIRED BY LAW IN SOME STATES.)**



## CAUTION

This gas piping system is designed for use with propane only. **DO NOT** connect natural gas to this system. Securely cap the inlet when not connected for use. After turning on gas, except after normal cylinder replacement, test gas piping and connections to appliances for leakage with soapy water or a bubble solution. **DO NOT** use products that contain ammonia or chlorine.



## NOTICE

All propane lines have been checked with air pressure. Dealers are required to recheck before delivery to retail customers.



## High Pressure Hoses with ACME Connectors



PROPANE High Pressure Hose/Main  
Supply Hose

Propane leaves the container through a hose with an ACME connector attached to the bottle, also having a “flow-limiting device,” designed to sense excessive flow. There are two functions of this device:

1. Should the container valve be opened too quickly, this device may close, stopping the flow of propane.
2. Should there be a rupture in the propane line, it will reduce the flow to a maximum of 10 (SCFH) Standard Cubic Feet per Hour. This device is designed to equalize propane pressures in about 5 seconds, generally being unnoticed. All pilot light valves must be turned off for equalization of pressure to occur.

### Main Supply Hose—Low Pressure

The main supply hose will be attached from the regulator to the brass manifold fitting in the frame of the unit. The swivel brass nut on the main hose will be your final attachment.

**There are several things to remember each time the container is removed:**

Be sure all connections are tested for leakage. Should you experience a propane “freeze up”, close the main valve and wait 15 minutes before trying again. Keep the container valves closed when traveling. Some states prohibit traveling with the propane container valves open, especially in underground tunnels on expressways.

After the camper is completely set up and you are prepared for camping enjoyment, follow these steps below for propane operation:

1. Be sure all burner valves, controls, and pilot light valves are closed.
2. Open the main valve on the propane bottle slowly to avoid a fast rush through the excess flow valve causing a “propane freeze.”
3. Listen carefully as propane begins to flow. If a “hissing” sound is heard for more than one or two seconds, close the valve and search for a potential leak. Solve the leak before proceeding.
4. Light appliances as needed and directed in the appliance section of this manual.



## WARNING

**Portable fuel-burning equipment, including wood and charcoal grills and stoves, should not be used inside the recreational vehicle. The use of this equipment inside the recreational vehicle may cause fire or asphyxiation.**



## NOTICE

**The entire propane distribution system and appliances have gone through complete factory and dealer tests for any leakage. When traveling with your RV, normal vibrations and road movement may cause connections to loosen and develop leaks. For normal maintenance, we advise all owners to test for leakage at least once per year or more often. You may request your dealer to perform a maintenance check each spring.**



## Checking for Leaks

Should you encounter an odor, possibly propane, turn off all open flames and begin a systematic search for leaks on the complete propane system. **NEVER** use a match. Use a soapy water solution that contains no ammonia or chlorine content to check for leaks. If a leak is identified, bubbles will appear. Always use 2 open end or 6-point wrenches when tightening brass connections to prevent the twisting of copper.



## DANGER

**DO NOT** use a gas cooking appliances for comfort heating. This can lead to carbon monoxide poisoning which can lead to death or serious injury.



## WARNING

Gas cooking appliances need fresh air for safe operation. Before operating: open vents or windows slightly or turn on the exhaust fan prior to using cooking appliances. Gas flames consume oxygen, which should be replaced to ensure proper combustion. Improper use can result in death or serious injury.



## DANGER

### IF YOU SMELL PROPANE:

1. **EXTINGUISH ANY OPEN FLAMES AND ALL SMOKING MATERIALS.**
2. **SHUT OFF THE PROPANE SUPPLY AT THE CONTAINER VALVE(S) OR PROPANE SUPPLY CONNECTION.**
3. **DO NOT TOUCH ELECTRICAL SWITCHES.**
4. **OPEN DOORS AND OTHER VENTILATING OPENINGS.**
5. **LEAVE THE AREA UNTIL THE ODOR CLEARS.**
6. **HAVE THE PROPANE SYSTEM CHECKED AND LEAKAGE SOURCE CORRECTED BEFORE USING AGAIN.**

**IGNITION OF FLAMMABLE VAPORS COULD LEAD TO A FIRE OR EXPLOSION AND RESULT IN DEATH OR SERIOUS INJURY.**

## Propane Gas Consumption

All your propane appliances are operated intermittently. Your furnace is naturally the appliance using the most fuel, especially if freezing conditions are present outside. On a very cold and windy day, it is conceivable the unit could consume most of a 20 to 30-pound propane bottle.

Propane consumption depends mostly upon individual use of appliances and the length of time operated. Each gallon of propane produces about 91,500 BTUs of heat energy. Following is a list of typical appliance consumption when turned on fully for one hour of operation.





## CAUTION

If you have double bottles and a standard regulator on your RV, use only one bottle at a time. Otherwise, the propane supply will be drawn equally from both bottles until supply has been totally exhausted. Using one bottle until it is empty, then using the second bottle will allow you to fill the empty bottle at your convenience without being totally out of propane.

### Appliance

#### LP GAS CONSUMPTION

Water heater: 12,000 BTU

Furnace: 16,000-35,000 BTU

Stove/Oven: 6,500-9,100 BTU

Refer (3, 4 Cubic) 875-2,200 BTU



## DANGER

All pilot lights, appliances, and their ignitors (see operating instructions) should be turned off before refueling the fuel tank and/or propane containers. Failure to comply could result in death or serious injury.

## Water Heater Safety Information

### Operating Instructions – Propane:

- A. This appliance does **NOT** have a pilot light. It is equipped with an ignition device which automatically lights the burner. **DO NOT TRY TO LIGHT THE BURNER BY HAND.**
- B. This is an automatic propane valve, no adjustments are necessary. **DO NOT** attempt to repair the propane valve. **This may result in a fire or explosion.**
- C. **DO NOT** use this appliance if any part has been under water. Immediately call a qualified service technician to inspect the appliance and to replace any part of the control system and any gas control which has been under water.
- D. Before operating the water heater, check the location of the vent to make sure it will not be blocked by the opening of any door on the trailer. If it can be blocked, **DO NOT** operate the water heater with the door open.

If the burner will not come on, the following items should be checked before calling a service technician:

1. The switch is turned off.
2. The gas supply is empty or turned off.
3. The reset button on ECO is tripped.
4. Turn off the gas supply.

Reference maintenance manual.





## Interior

### Blinds

All shades **MUST** be in the upright position for travel to avoid the metal holder from being in contact with the garnish on the window to avoid scratches.

Nightshades installed, have cords that are anchored to the lower parts of the windows and need to be secured for operation. Loose furniture, such as dinettes and free-standing chairs, need to be secured to prevent movement. **Damage can occur during travel if these items become in contact with walls, cabinets, supplies, etc.**



### WARNING

**These individual tassel cords reduce the strangulation hazard in the pull cord by removing the loop.  
Do not tie the cords together.  
Check periodically to make sure the cords have not twisted into a loop.  
This device will not prevent strangulation hazard if young children wrap pull cords around their necks. Always keep cords out of the reach of young children.**



### CAUTION

**While traveling all mini blinds need to be in the “up” position to avoid swinging and scratching paneling, even with brackets installed on the bottom of the window.**



## Murphy Bed

(Optional)

Murphy Bed Set-up and Stowing



**MAXIMUM CAPACITY OF THE MURPHY BED IS 500 POUNDS.**

**DO NOT EXCEED THIS LIMIT.**



## WARNING

**SUPERVISION** – For your safety and the safety of others, please do not allow any individual under the Murphy bed when lowering, raising, or stowing the bed. Children should be supervised at all times and adults should likewise instruct children about the hazards of being under the bed when lowering, raising, or stowing the bed.

**PINCH POINTS** – Beware of pinch points between the base of the Murphy bed and the sofa when lowering and between the base of the bed and the storage compartment when raising and/or stowing the bed. Also, beware of the pinch point between the footboard and your feet when lowering the bed and the footboard and the base of the bed when raising to stow.

**CRUSH HAZARD** – Lowering the bed may cause injury to oneself or others. Keep clear of the bed base when lowering or raising the Murphy bed and ensure that no adult, child, or pet are under or near the bed when raising to stow.

**USER EQUIPMENT** – Make certain that no person is on the Murphy bed when it is being raised or if the bed has not properly been latched in place after it has been lowered for use. If the bed is not properly latched in place during use, it may inadvertently raise up if there is enough weight on the head of the bed past the pivot point. In that circumstance, a person may be trapped between the bed and the storage compartment, which may result in serious personal injury or death.

In addition, if someone is on the bed when it is being raised to bestowed, that person may be trapped between the bed and the storage compartment, which may result in serious personal injury or death.



## Murphy Bed Assembly



1. This is a job for at least two people, one on each side of the bed. Before lowering the bed, make certain the sofa couch has been folded down and that no person is under the bed area.
2. While holding the bed with your free hand, pull back the barrel latch pins on both sides of the bed, locking the bed in the upright position. The bed should be unlocked and ready to be lowered.
3. Once the pins are unlatched, slide your hands underneath the footboard, at the top of the bed base on either side and slowly lower the bed to the horizontal position. The footboard will unfold at that time so beware of pinch points and the board hitting your feet. The bed should then rest on the footboard in a horizontal position.
4. There is a barrel latch on the right side of the nightstand. Locate it and make sure that the bed is latched in the horizontal position with the barrel latch before use. If it is not latched, then there is a risk that the bed may swing up into the upright position if a person places too much weight at the head of the bed or in the storage compartment.
5. When stowing the bed, make certain at least two people do so and no one or no object is on the bed or in the storage compartment.
6. Unlatch the bed and slowly raise it to the upright position in the storage set up position. Again, beware of pinch points and the footboard hitting your hands while the bed is being raised. While holding the base of the bed, latch the barrel pins on either side of the bed. Make sure the bed is securely stowed before travel.

## Appliances

### (READ BEFORE OPERATING)

VENTURE RV uses brand name, quality-built equipment, as guided by current codes and standards. Some appliances are built and equipped to operate on propane gas only. **DO NOT ATTEMPT TO OPERATE ON NATURAL, BUTANE, OR METHANE GAS.**

Each appliance has its own specific manual, written and published by its manufacturer. These manuals supply needed information about the appliances in your recreational vehicle.

### Fireplace (Optional)

A fireplace may be installed in the unit, to be used for heat. It produces 5000 BTU and operates on 120-volt AC power. A circuit breaker is placed in the distribution box, supporting protection for overloads and short circuits.

The master switch must be turned on before anything will happen.

Turn the power on and continue as desire.

The fireplace consumes 1500 watts (12.5) amps of energy. Use the owner's manual to ensure proper use. Additional information can be found in the manual supplied by the manufacturer.



## Exterior

### Step Assembly

There are 2 styles of step assemblies that are being used. Under doorsteps and inside doorsteps.

### Under Door (Folding) Steps

Before entering your recreational vehicle, place your hand in the center of the step assembly. Pull the center bar outwards. The step assembly will raise slightly and then out, away from the unit. The lower step will unfold 180° to a useable position.



## CAUTION

After lubrication, on pivot points, be sure no lubricant is remaining on steps, causing a person to slip.

## Inside Door (Solid) Steps

Open the entrance door and the step assembly will be inside, standing vertical. Grab the handle (blue or yellow) and turn the latch. Hold the step assembly so it does **NOT** fall out of the door.

Lower the assembly slowly until the step feet are supported by the ground. Before lowering, observe, and obey the 4 decals attached to the steps concerning handling and assembly. Adjust the feet as needed to keep the assembly level and safe. Use the grab handle as needed to enter/exit the RV. No lubrication on the steps is needed.



## Windows

### Solid window

Which does **NOT** open.



### Slider window

One panel will open and slide in a horizontal or vertical direction.



## Egress (Escape)

Required by code, to be placed in the wall on the opposite side of the entrance door. These windows have a swing out panel with a screen in the window frame itself. These may have an unlocking handle or 2 latches, one on each side needs to be unlatched to swing the panel open. Before traveling, be sure latches are securely latched.



## Crank Out Window

Crank out window uses a twist handle located either in the center or to the right corner that you will need to turn the handle to the right to open and left to close.

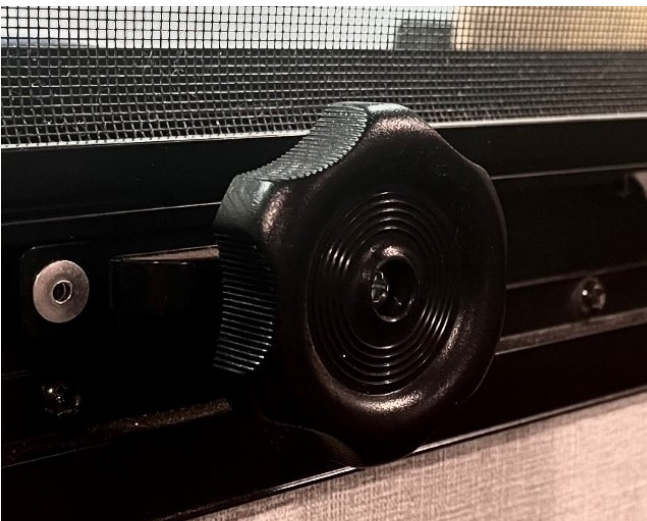

## Frameless Window

Frameless Window uses a crank or lever located toward the center of the window that you push forward to open and pull back to close.



## Doors

The lock and latch assembly on the entrance door contain 2 locks. The handle, for opening the door and the deadbolt. Both locks use the same key, all doors are keyed alike. Each RV comes with 2 keys. The propane container compartment doors are not permitted to have key locks. Locks on trunk doors need a small quantity of silicone lubricant sprayed internally 2 times per year to keep them functioning correctly. Screen doors may have a hook/lever type of latch. First, a “roller” latch and secondly, a “hook” latch, which needs to be tripped to open. Pull the lever downward to release the door.



## Exterior Ladder

A ladder is standard or available as an option on most units to provide access to the unit roof. Ladders are rated to handle up to 250 pounds at a time when climbing onto the roof. **Do NOT store articles on the ladder during travel. If you do so, the warranty will become void on the ladder.**



## Outside Shower (Optional)

A convenient faucet assembly with hot and cold water is available for exterior use on the outside of the camper, such as washing, rinsing your hands, and the washing of utensils and other needs. On certain models, you will find a “spray port”, with a coil hose, in your LCC system. Others will have a standard shower box located on the side of the unit.



## Outside Kitchen (Optional)



1. The cooktop has no standing pilot light. Each use requires re-lighting the burner. There is a removable propane hose that is included with quick connectors for propane.
2. A refrigerator is included. Small units use a 1.6 cu.ft. and large units use a 3.2 cu.ft. No 12-volt or propane is required. Both sizes operate on less than 1.5 amp of power or less.
3. A small sink and faucet (optional) may also be a part of the outside kitchen. An outside shower/port is included with a hose. **Don't forget to winterize your outside kitchen, especially the drain trap.**
4. A second microwave may be included on **SOME** models. Only one microwave can be used at any given time.
5. Another item for the outside kitchen may be an entertainment system with a TV on a swing out arm assembly and a stereo radio. Signal will be received through the roof antenna, cable, satellite, or possibly a ground portable receiver.



## WARNING

**When using this outdoor cooking area, the vehicle must be level and stabilized. DO NOT violate manufacturers' instructions on required clearances for cooking appliances during use. DO NOT store cooking appliances until cool to touch. This can lead to a fire and explosion and result in death or serious injury.**

**NOTE: VENTURE offers additional packages/options for some units. Ask your dealer on what your available options are for your specific unit.**





## Method #1

# Winterizing your Recreational Vehicle

Preparing the trailer for cold weather is very important. Failure to prepare the RV for cold weather will result in the water systems to freeze causing them to break. Damages related to freezing conditions are **NOT** covered under the terms of the Limited Warranty.

## Extended or Cold Weather Use

Your Recreational Vehicle has been built for enjoyment in a recreational manner. This recreational vehicle is **NOT** intended to be used as full-time living quarters. Using this unit in freezing conditions is **NOT** recommended. If you need to use your unit in the freezing weather, follow these guidelines. Any problems resulting from freezing weather are **NOT** covered under your Limited Warranty.

1. For winter use in freezing conditions, more protection may be required. Use skirting and/or insulation below floor level to provide additional protection.
2. Remember, water freezes at 32°F or 0°C whether the water is fresh or drainage. Proper care must be used to protect any system. Local recreational vehicle dealers and campground personnel may be able to advise you on needed protection.
3. Energy requirements, such as propane and electrical supplies, must be adequate. Protect your propane regulator from freeze-ups.
4. During cold weather, you will experience more condensation than normal. Use ventilation or a dehumidifier as needed.

## Using the water system during freezing weather

A towable RV was **NOT** intended to be used during freezing weather unless special precautions are taken. There is no product that can be added to the water to ensure freeze protection when the system is in use, other than RV antifreeze. **DO NOT** drink the water which contains any type of antifreeze or use it to shower.

## There are two methods of winterizing your unit after draining and flushing your tanks:

1. Open all faucets, low point drains, toilet valves, and water heaters to drain all water. Leave these open during this procedure.
2. Start the pump and operate until all the water has been removed. This process takes about 10-30 seconds.
3. After the water has been drained, use an air hose from a compressor and an adapter attached to the city water fill. In about 3 to 5 minutes most of the water will be blown out of the lines.
4. Pour one (1) pint of non-toxic antifreeze into each P-trap. Each sink and bathtub has a P-trap.

## Method #2

1. Turn off the pump.
2. Drain the water heater and the entire water system.
3. Change the flow direction on the bypass kit by turning both valves 90° to prevent anti-freeze from entering the water heater. Valve handles that are in the vertical position are for bypassing the water heater. Horizontal positioning will allow water to flow into and through the water heater.
4. Open all of the faucets in the unit.
5. Remove the inlet line from the water pump. (For units without a siphon hose)
6. Make an adapter hose kit to attach to the water pump, when accessible. Attach the fitting end into one end of the water line/hose, which attaches to the water pump.
7. The open end of the hose is to be inserted into a gallon jug of anti-freeze liquid.
8. Turn on the pump to supply the RV system with antifreeze. You may use two to three gallons.
9. For units with a siphon hose, adjust the valves as required for winterizing. Place the open end of the siphon hose into the container with anti-freeze. Turn on the pump to fill the water system with anti-freeze.
10. Take 1 pint of antifreeze and place it into the drains to protect the p-traps from freezing.

**NOTE: Some models will require a screwdriver to remove a panel to gain access to the bypass kit, water pump, and plumbing components.**



## Condensation

Where condensation comes from, what it causes, and various solutions.

### Causes:

- A. Condensation occurs when warm moist air contacts a cold surface, such as rain touching a tent. Having fabric inside of the unit, and individuals breathing warm moist air against it, may also cause a rise of interior condensation.
- B. When cooking food or taking a shower, warm moist air circulates throughout the unit attaching itself to cooler surfaces, forming beads, and running down walls or windows
- C. Normal breathing will emit approximately 1/2 pint of moisture into the air per person, per day. The more occupants, the greater quantity of condensation.



## CAUTION

**Continuous living in your recreational vehicle could cause accelerated wear to components above recreational use.**

### Solutions:

- A. When taking a shower, open the bath roof vent approximately ½ inch allowing moisture to escape.
- B. Use the power vent over the range when cooking.
- C. If condensation is found in cabinets or closets, open the door slightly to equalize the temperature and provide ventilation.
- D. Open window and roof vents when possible to allow warm moist air to escape.
- E. Under extreme conditions, a dehumidifier may be used to remove moist air.

**Condensation is not a warranty issue!**

## Interior Ventilation

A new unit always has a peculiar aroma in it due to all the components used to build the unit, such as paneling, carpet, and fabrics, etc.

Allowing fresh air to move and circulate throughout a new recreational vehicle is beneficial for several reasons.

1. Components used to build RV's always have a "new" smell to them, possibly irritating to the respiratory system of the human body on warm days.
2. Fresh air is good for the human body unless allergies play a factor.

**Following are numerous ways to circulate air within your unit:**

1. Open windows on non-rainy days, allowing air exchange between indoors and outdoors.
2. Open the power hood vent above the cooking stove to send heat and food smells outside.

**There are numerous types of roof vents:**

- Standard air flow using gravity flow method.
- Power (12V or 110V) vents will move air faster.
- High-Volume power vents, operating in 12-volt power can exchange the air in a unit in several minutes if windows are open accordingly. If there is a fan in the rear, open front window(s).

Different brands/models have different features, such as remote control, rain sensor, variable speed control switch, etc. Carefully read the operating instructions placed in the unit by the manufacturer of the various components.



